

Picture showing Adaptor base c/w solenoid

MODEL 7144 SINGLE SOLENOID ADAPTOR BASE

The 7144 is equipped with a flow control to provide an adjustable speed for rudder positioning. It also provides flow control for an auto-fill system. This small flow control can be adjusted to provide a very small volume of oil to be delivered to the header tank. The header tank, in turn, will require an overflow line to the main tank. The basic purpose for having the adaptor base is to provide control over the rudder in either direction. Its maximum flow capacity is six gallons per minute and it can be equipped with either an open or a closed centre soft shift solenoid valve. If more than one valve is used in a single system, closed centre solenoid valves are required on both. It is also recommended to have volume compensated pumps in the steering gear system to reduce heat and for better economy.

ORDERING INFORMATION

7144	=	without solenoid
7144-DC12	=	with 12 volt solenoid
7144-DC24	=	with 24 volt solenoid
7144-DC32	=	with 32 volt solenoid
7144-AC110	=	with 110 volt AC solenoid

DIMENSIONS AND PARTS LIST MODEL 7144

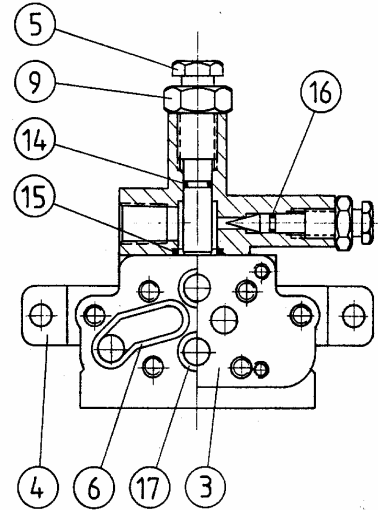
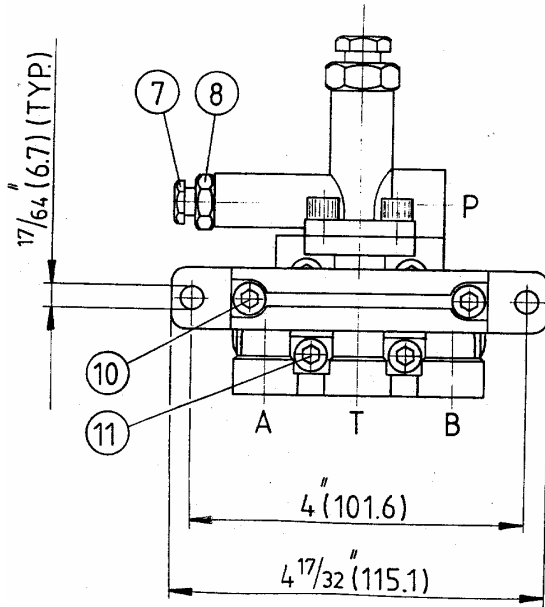

All dimensions in inches (mm)

ITEM	QTY	PART NUMBER	DESCRIPTION
1	1	7144-0001	Body
2	1	7144-0002	Adjusting Block
3	1	7144-0003	Solenoid Plate
4	1	7144-0004	Foot
5	1	7144-0005	Flow Needle (large)
6	2	7144-0006	Gasket
7	1	7145-0007	Flow Needle (small)
8	1	1022-0262	Hex Jam Nut
9	1	1002-0264	Hex Jam Nut
10	2	1002-1028	Socket Hd Cap Screw
11	2	1002-1014	Socket Hd Cap Screw
12	3	1002-1008	Socket Hd Cap Screw
13	2	1002-1010	Socket Hd Cap Screw
14	1	1101-0010	O-Ring
15	1	1101-0016	O-Ring
16	1	1101-0008	O-Ring
17	2	1101-0012	O-Ring

