









11 Flexible Impeller Pumps









| | MODEL NUMBER | FLOW PATTERN/ CONNECTION | FITTING/PORT | DRIVE | FLANGE MOUNT | WEIGHT | SIZE | GPM (LPM) | |
|---|--------------|--------------------------|------------------------------------|----------|--------------|----------------|--|------------------|--|
|  | 5850-0001 | U | 3/4" (19mm) NPT | Coupling | Engine | 6lb (2.7kg) | 5-5/16" (13.5cm) long 4-1/4" (10.8cm) wide 3-1/4" (8.3cm) high | | |
|  | 12600-0001 | U | 3" (76mm) hose | Gear | Engine | 20lb (9kg) | 7" (17.8cm) long 7-3/8" (18.7cm) wide 8-1/2" (21.6cm) high | | |
|  | 7420-1001 | U | 1-1/4" (32mm) NPT | Pulley | Pedestal | 10.5lb (4.8kg) | 8-1/16" (20.5cm) long 5-1/8" (13cm) wide 5-1/16" (12.9cm) high | 62 GPM (235 LPM) | |
|  | 6400-1051 | - | 1-1/4" (32mm) NPT | Pulley | Pedestal | 10.5lb (4.8kg) | 8-1/16" (20.5cm) long 5-7/8" (15cm) wide 4-7/8" (12.4cm) high | 62 GPM (235 LPM) | |
|  | 18400-0050 | U | 3/4" (19mm) NPT | Coupling | Engine | 6lb (2.7kg) | 5-5/16" (13.5cm) long 4-1/4" (10.8cm) wide 3-1/4" (8.3cm) high | | |
|  | 3270-0001 | U | 3/4" (19mm) NPT | Coupling | Engine | 4lb (1.8kg) | 4-1/4" (10.8cm) long 4-1/8" (10.5cm) wide 3-7/8" (9.8cm) high | | |
|  | 7420-1001 | U | 1-1/4" (32mm) NPT vertical ports | Pulley | Pedestal | 10.5lb (4.8kg) | 7-1/32" (17.9cm) long 5-7/8" (15cm) wide 4-7/8" (12.4cm) high | | |
|  | 6400-1051 | - | 1-1/4" (32mm) NPT horizontal ports | Pulley | Pedestal | 10.5lb (4.8kg) | 7-1/32" (17.9cm) long 5-7/8" (15cm) wide 4-7/8" (12.4cm) high | | |

| | MARINIZED BY: | | | | | | | CATEGORY/ APP |
|--|---------------|----------|---------------|-------------|-------------|------|---------|------------------|
| | CUMMINS | FLAGSHIP | PALMER LEHMAN | CHRIS-CRAFT | CATERPILLAR | ONAN | PERKINS | |
| | | X | X | X | | | | EC |
| | X | | | | | | | EC |
| | | | | | X | | | EC |
| | | | | | X | | | EC |
| | | | | | | X | | EC |
| | | | | | | | X | EC |
| | | | | | X | | | EC |
| | | | | | X | | | EC |

11 Flexible Impeller Pumps

SELECTION GUIDE



| | MODEL NUMBER | FLOW PATTERN/ CONNECTION | FITTING/PORT | DRIVE | FLANGE MOUNT | WEIGHT | SIZE | GPM (LPM) |
|---|--------------|--------------------------|---------------------|----------|--------------|---------------|---|-----------|
|  | 10950 | H | 3/4" (19mm) BSP | Gear | Engine | 7lb (3.2kg) | 6-1/2" (16.6cm) long 4-1/2" (11.5cm) wide 5-1/8" (13cm) high | |
|  | 21140 | H | 1" (25mm) BSP | Gear | Engine | 8lb (3.6kg) | 7-1/4" (18.5cm) long 4-1/2" (11.5cm) wide 5-1/8" (13cm) high | |
|  | 29500-1001 | V | 1-1/8" (28mm) hose | Coupling | Engine | 2.5lb (1.2kg) | 4-3/4" (12.1cm) long 4" (10cm) wide 4" (10cm) high | |
|  | 9700-01 | U | 1" (25mm) flanged | Coupling | Engine | 6lb (2.8kg) | 5-3/4" (14.9cm) long 4-3/4" (12.1cm) wide 3-7/8" (9.9cm) high | |
|  | 9970-200 | U | 3/4" (19mm) BSP | Coupling | Engine | 4lb (1.8kg) | 5-5/8" (14.2cm) long 4" (10cm) wide 3-3/8" (8.6cm) high | |
|  | 10970 | U | 3/4" (19mm) NPTF | Gear | Engine | 7lb (3.2kg) | 5-5/8" (14.2cm) long 4-3/4" (12cm) wide 4-1/2" (11.5cm) high | |
|  | 10970-21 | U | 3/4" (19mm) flanged | Gear | Mount | 8lb (3.6kg) | 5-7/8" (15cm) long 5-5/8" (14.3cm) wide 4-1/2" (11.5cm) high | |

| | MARINIZED BY: | | | | | | | CATEGORY/ APP |
|--|---------------|---------|--------|------|-------|-----------|-------------------|------------------|
| | C-POWER | LANCING | LEHMAN | SABB | SABRE | WATERMOTA | PERKINS | |
| | X | X | X | X | X | X | | EC |
| | X | X | X | X | X | X | | EC |
| | | X | | | | | X | EC |
| | | | | | | | X | EC |
| | | | X | | | | X | EC |
| | | | | | | | X (4.236) | EC |
| | | | | | | | X (4.236, m90) | EC |

11 Flexible Impeller Pumps

INTRODUCTION



Jabco Original Flexible Impeller Pumps –
Pedestal, Clutch & Engine Cooling

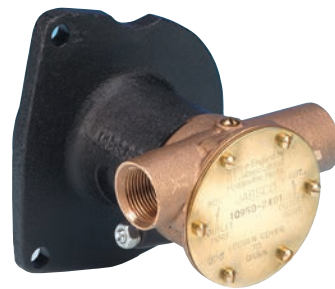
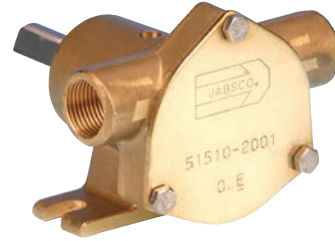

HOW IT WORKS



Flexible vanes create increased volume when leaving the eccentric cam creating a vacuum, and thus drawing in liquid, instantly priming the pump.



As the flexible vanes rotate, the liquid is carried through the pump from the inlet to outlet port, each successive vane drawing in liquid.



When the flexible vanes again contact the eccentric cam they bend with a squeezing action which provides a continuous, uniform discharge of liquid.



FEATURES

- **Versatile:** The flexible impeller pump combines the priming feature of positive displacement type pumps with the general transfer ability of centrifugals. It will pump either thin or viscous liquids and can handle more solids in suspension than other types of rotary pumps. It operates at low or high speeds, can be mounted at any angle and pumps in either direction with equal efficiency.
- **Self-Priming:** Pumps instantly with dry suction, lifts up to 10' (3m) – up to 25' (8m) when wetted. Permits cleaner, safer installations. No foot valve required.
- **Simplicity:** One moving part – a tough, long-lived, wear-resistant flexible impeller, lubricated by the liquid being pumped. No metal-to-metal pumping action – no gears to jam, clog or become noisy.
- **More Capacity:** Flexible impeller pumps, in general, require less space because they deliver greater flow for weight, size and price than other types of pumps.

The data given for the engine cooling systems and pump selection is for guidance only. It does not cover high-performance engines. You should always consult the engine marinizer.

It is important that Jabsco Engine Cooling Pumps and Systems are matched during the design of ships' engine installations. Once installed, safety margins must be safeguarded, i.e., the emphasis must be on *preventive*, not corrective maintenance.

Cooling systems most commonly used for marine propulsion engines are:

- Heat exchanger cooling
- Keel cooling
- Direct cooling

PRESSURE RANGES

Standard impellers

Suitable for continuous operation up to the following limits:

- 1/4", 3/8" and 1/2" port sizes to 40' (12m) head, 17.3 psi (1.2 bar).
- 1" to 2" port sizes to 70' (20m) head, 30.3 psi (2 bar).

Special high pressure impellers

Available for certain models. Impeller life will be extended by operating in the lower portion of recommended pressure range.

TEMPERATURE RANGE

- 45° to 180°F (7° to 80°C)

For fluids less than 45°F (7°C) consult with the factory.

OPERATING SPEEDS

Ball bearing pumps

- 1/4" or 1/2" ports: 3600 rpm max.
- 3/4" or 1" ports: 3000 rpm max.
- 1-1/4" ports: 2200 rpm max.
- 2" ports: 2200 rpm max.

Heat Exchanger Cooling

This is also known as a closed system, i.e., the primary cooling circuit is isolated from the surrounding atmosphere.

A centrifugal pump circulates fresh, treated water through the cylinder block passages and around the tube stack of a heat exchanger. The Jabsco raw water pump draws raw water (from sea or lake) through the ship's hull inlet and pumps it through the heat exchanger tubes where it removes the heat transmitted from the primary circuit before discharging overboard.

The heat exchanger, which can be single-pass or two-pass type, should be capable of handling approximately 10% more than the maximum engine heat rejection rate and may be fitted separately or as an integral part of the expansion/header tank. This tank allows venting of air or combustion gasses absorbed by the cooling water during engine operation and provides a positive pressure on the fresh water pump inlet. This pump, fitted in the coldest part of the primary circuit, has a capacity which will maintain a water temperature differential of approximately 45°F (8°C) across the cylinder block at full load. The engine operating temperature is regulated by a marine thermostat to about 185°F (85°C) on most engines. To provide an adequate safety margin for commercial diesel engines, which may be expected to operate more than 2500-3000 hours per year, size and rpm of the Jabsco raw water pump should be selected to give a flow capacity of approximately 15 GPM (57 LPM) for every 100hp maximum engine load and rpm.

If an exhaust manifold is fitted in the raw water or fresh water circuit, the raw water pump flow capacity should be 10-15% higher.

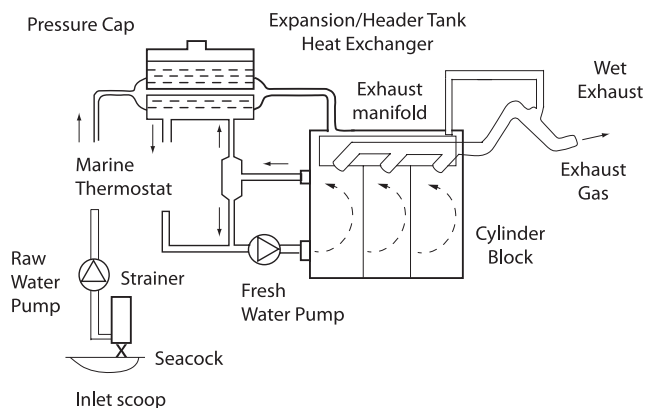

Additional coolers, such as oil coolers or charge air coolers, must be fitted *after* the pump, but in a compromise between reliability, size and weight, and pump delivery. Head should be about 10-13 psi of water at maximum rpm.

Safety margins in pump inlet systems are extremely critical, so any restrictions or bends, other than seacock and inlet strainers, are to be avoided at all costs (see Suction System page 97).

Raw water from the exhaust manifold is often injected into the exhaust pipe (*after* an exhaust elbow to prevent raw water flowback into the cylinders), which may then be ducted through areas where a hot pipe would create a hazard. This is known as a "wet exhaust" system. In addition, mixing of water with exhaust gases will reduce exhaust noise. However, on small engines the raw water flow should not be less than 2.5- 4 GPM (9.5-15 LPM) for adequate silencing.

11 Flexible Impeller Pumps

INTRODUCTION



Keel Cooling

In principle, this is similar to a heat exchanger cooled system, but the raw water circuit and heat exchanger have been replaced by pipes attached externally to the vessel's keel.

Pipe bore and surface area must be adequate for effective dissipation of heat from the primary circuit to sea or river water. In some installations where the flow capacity of the centrifugal circulating pump is insufficient due to system pressure losses through keel pipes, cylinder block and exhaust manifold, a Jabsco pump may be used (flow capacity approximately 30 GPM [113 LPM] for every 100hp at maximum engine load and rpm).

Alternatively, the ship's steel hull may be used as the cooling surface and the heat transmitted directly to the surrounding sea or river water from a tank welded inside to the bottom.

The "dry exhaust" can be made a "wet exhaust" by a separate raw water pump.

The expansion/header tank may be fitted separately. In which case, it must be connected directly to the circulating pump inlet and the primary circuit adequately vented into the tank.

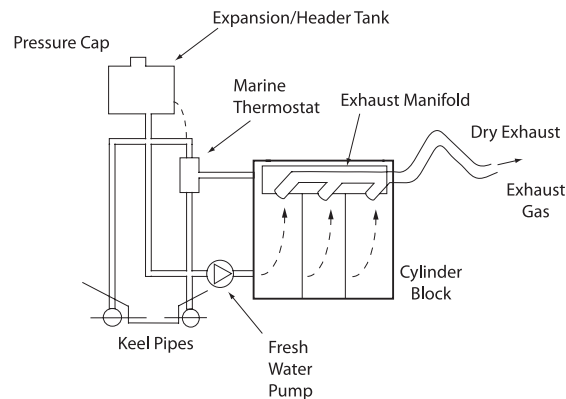

Direct Cooling

Raw water is pumped directly through the engine block. However, as the temperature of the water entering the block is ambient, the outlet temperature needs to be much lower than in an indirect cooled engine to reduce the formation of scale and salt deposits and thermal stresses in the cylinder block.

Lower operating temperature means that engine performance will be considerably less efficient, and direct cooling systems should, therefore, not be used on commercial craft engines.

For weekend pleasure craft engines which operate no more than 50-100 hours per year, reliability margins will probably be maintained for a number of years until deposits in the engine cooling passages begin to affect heat transfer to the cooling water.

Engine operating temperature is best controlled by a marine thermostat rather than a manually operated valve.

For cold engine start, the thermostat will be closed and most of the cooling water (about 10 GPM [38 LPM] for every 100hp at full load and speed) will bypass the engine via a spring-loaded back pressure valve and discharge into the exhaust manifold. A small bleed hole in the thermostat will ensure a slow circulation of cooling water through the cylinder block to prevent "hot spots" while the engine is warming.

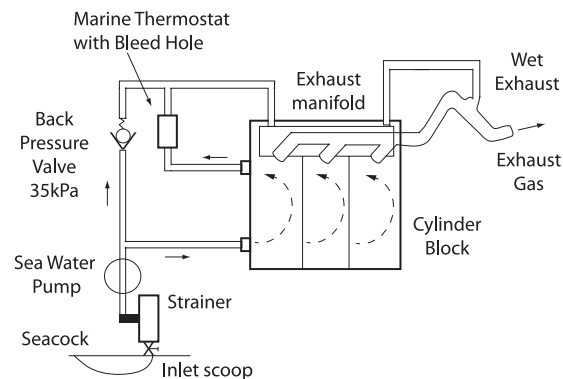

Safety Margins

The raw water flow capacities indicated earlier are for diesel engine cooling systems and include a safety margin of some 30% to ensure adequate engine cooling under adverse operating conditions.

As gasoline engines, unlike diesel engines, have a high heat rejection rate at idling speed, an increase in pump flow capacity of some 10% at maximum rpm is recommended.

While flow capacities can be affected by salt deposits or scale in pipes due to operation in tropical regions, seawater pollution or age and wear of pumps and systems in general, this is usually a gradual process with ample warning that preventive maintenance can counteract.

Far more serious is a reduction in cooling water flow due to adverse conditions caused by an inadequate system.

When marine vegetation such as seaweed gets stuck in seawater inlet strainers of insufficient mesh or hole size, this can cause a significant reduction of the cooling water supply to the pump.

On the other hand, no amount of pump flow capacity will safeguard against a sudden but total blockage – for example, a plastic bag covering up the hull inlet. System safety margin can be substantially increased by providing two separate hull inlets usually on either side of the keel, joining the pump inlet pipe below the water line. In actual practice, the likelihood of both inlets being covered simultaneously has been found to be insignificant.

As heat exchanger and cooler manufacturers' recommendations for a given engine performance and corresponding pump flow will include appropriate safety margins for minimum and maximum flow, it should be kept in mind that excessive water velocities through the heat exchanger pipes due to "overkill," i.e., fitting oversize cooling pumps, may cause pipe erosion and accelerated pump wear through excessive pump operating pressures.

Low water velocities through heat exchanger tubes, on the other hand, could result in the formation of sludge. Therefore, too small a pump (insufficient safety margins) may cause inefficient operation of heat exchangers and coolers for much of the time.

Suction System

To provide reliable performance under seagoing conditions, a raw water cooling pump must operate in a correctly designed cooling system. It is, therefore, essential that cooling water should reach the pump without having to overcome undesirable resistance or restrictions.

The following general rules are given for guidance:

- Suction pipe bore must not be smaller than the pump inlet connection, but if total suction pipe exceeds 10' (3m) in length, the bore should be one size larger, particularly if the pump is operated at high speeds. Use the same size bore pipe throughout, i.e., avoid sudden enlargements or contractions. Use long tapered sections of pipe at any change in pipe bore.
- The suction pipe run should be as straight as possible, i.e., avoid unnecessary bends. Do not use square or standard elbows, instead use long sweep bends.
- *Do not* fit gearbox or engine oil coolers in the pump suction system. Always install after the pump.
- Seacocks of the same nominal size as the suction pipe work should be of the ball or plug type, giving full through bore in the open position. The handle position should clearly indicate whether seacocks are open or closed.
- Seawater inlet strainers should have a hole or mesh size of at least 1/8" (3mm) diameter and up to 3/16" (5mm) for larger pumps, but smaller than the heat exchanger tube bore.
- Check frequently that inlet strainer is not clogged. If in doubt clean thoroughly.
- Fast boats (over 12-15 knots) and planing craft must be fitted with inlet scoops positioned in a permanently wetted area of the ship's hull to create sufficient inlet pressure at higher boat speeds. Flush inlet fittings are not suitable for fast boats.

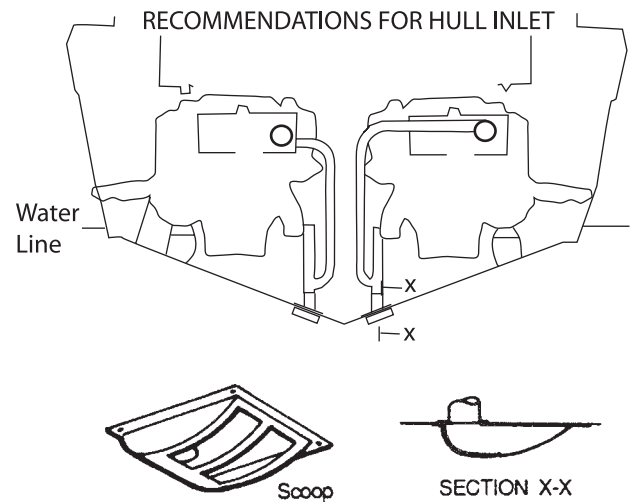

11 Flexible Impeller Pumps

INTRODUCTION



Pump Selection

Most proprietary marine engines are already fitted with specially adapted flange mounted Jabsco cooling pumps driven by gears or couplings of various descriptions.

A belt drive from the crankshaft pulley will enable almost any standard foot mounted bronze Jabsco pump to be selected, provided that the required cooling flow rate is obtained without operating the pump at excessive speeds.

Global cooling water requirement for each 100hp at maximum engine load and rpm is at right.

DIESEL ENGINES

Heat exchanger cooling

18 GPM (68 LPM) – raw water

Keel cooling

36 GPM (136 LPM) – fresh water

Direct cooling

12 GPM (45 LPM) – raw water

GASOLINE ENGINES

Increase diesel engine figures by about 10%.

If exhaust manifolds are water cooled, increase pump capacity by a further 10-15%.

Pump Types

Selection may depend upon pump speed, space available and type of drive.

BALL BEARING PUMPS

For pump speeds in excess of 2500 rpm, ball bearing pumps should be used. Depending on size and duty, speeds of up to 5000 rpm are possible, but special attention to suction system conditions is then required (consult Jabsco).

Ball bearing pumps are available in heavy-duty and compact types.

HEAVY-DUTY PUMPS

This range is designed with two spaced bearings and mechanical rotary face seals to meet high reliability criteria under adverse operating conditions, i.e., excessive belt tension, high operating pressure, abrasive conditions found in shallow waters or in-shore operation. Pump bodies are either bolted to a bearing housing or body and bearing housing are a single, integral casting. These types of pumps are often unique to the application, but some varying pump types can share common bearing housings.

COMPACT PUMPS

This pump range is fitted with double row ball bearings, providing a low cost compromise between overall pump length and a limited heavy-duty capability.

Bearings are shielded, ensuring permanent lubrication by the special grease.

Pump Drive Failure

The majority of pump failures are caused by badly designed pump systems. Secondary causes of pump problems are unsatisfactory drive arrangements.

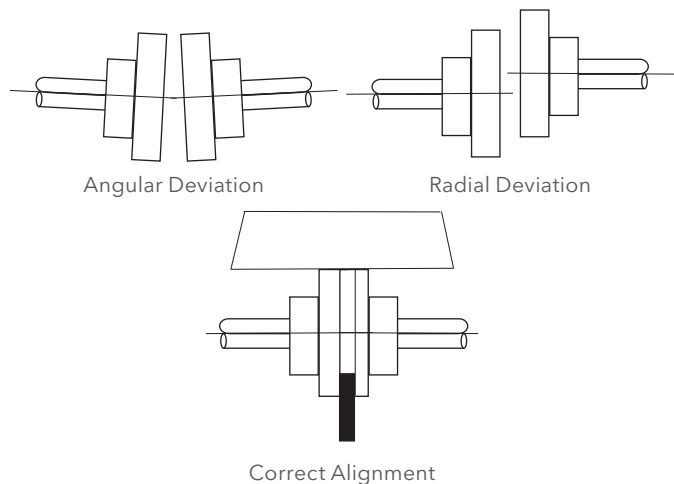

Pump Drives

DIRECT DRIVES

Misalignment between pump and drive shaft is a common cause of pump failure.

A flexible coupling is only "flexible" within limitations specified by the manufacturer. Excessive misalignment, particularly at high pump speeds, can cause noise, knocking, vibration, premature bearing failure, usually followed by pump leakage.

BELT DRIVES

The pump speed is determined by the engine pulley diameter and the need to maintain the pump pulley at a practical maximum size. Some engine crankshaft pulleys incorporate vibration dampening membranes resulting in large diameters at the V-groove. To lower pump speed relative to engine speed, it is necessary to use a pulley on the pump that is larger than the drive pulley. High engine speeds may, therefore, require oversize pump pulleys which preclude the practicality of a belt drive. Calculating a suitable size pump pulley (example):

$$\frac{\text{Drive Pulley Diameter}}{\text{Pump Pulley Diameter}} \times \text{Engine Speed} = \text{Pump Speed}$$

Excessive drive belt tension will cause rapid belt wear and may result in premature bearing failure. It should be possible to deflect a correctly tensioned belt between pulleys approximately 1/2"-3/4" (13-19mm) by applying finger pressure.

While excessive belt tension may be due to inadvertent overtightening, it should always be verified that it did not result from an inherent fault in the installation, e.g., if pump flow is insufficient due to a slipping belt caused by insufficient contact area between belt and pulley, any amount of tightening would not solve the problem permanently. Ideally, the contact area should be about 120° but not less than 90°.

If the engine is installed on flexible mountings, a belt driven pump must be mounted on the engine, never bolted to the vessel's structure. This is to avoid tensioning or slackening of the drive belt due to relative movements of the engine.

GEAR DRIVES

Drive gears fitted to "heavy-duty" flange mounted pumps are supported by the pump ball bearings and driven by one of the engine gears.

CRANK PULLEY MOUNTED DRIVE

A number of Jabsco pumps specially developed for high speed operation on gasoline and diesel engines are fitted with a multi-positional bearing housing bolted directly to the crankshaft pulley, thus eliminating mounting brackets, belts and pulleys.

As the pump body is supported by the ball bearing only, it must be prevented from rotating by means of a torque arm, designed and installed so as to avoid any side load on the bearing. Inlet and outlet hoses must be flexible, i.e., of adequate length (at least 10 times the hose diameter) so that the pump can be rotated freely over a few degrees by finger pressure only.

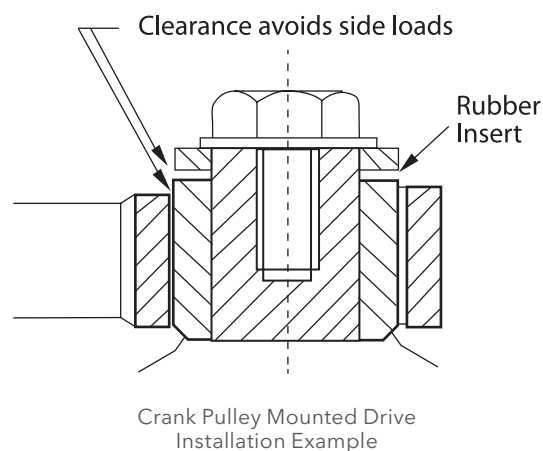
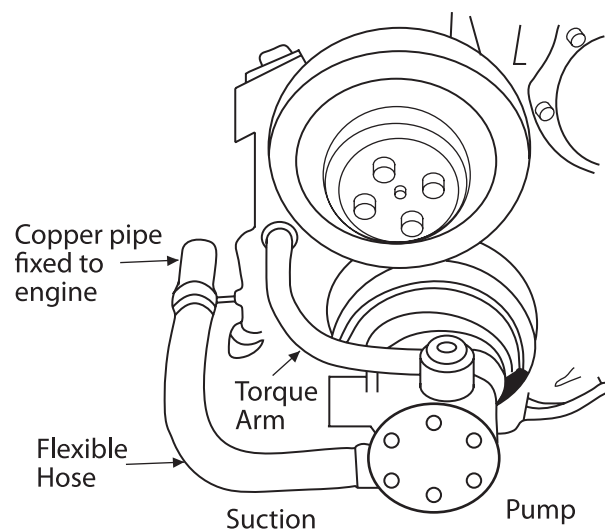
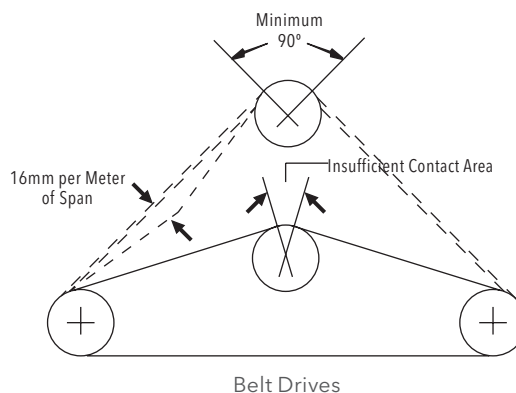

11 Flexible Impeller Pumps

PULLEY DRIVEN PUMPS



Jabco pumps have serviced major engine builders globally for more than 70 years. The self-priming flexible impeller pump is the industry recognized technology standard for leisure and work boat engine cooling. Being an original Jabco, you are assured the highest grade bronze and stainless steels are used in keeping your engine at peak operating temperature. Operating in either direction, with flows up to 83 GPM (314 LPM) and multiple port configurations, flexible impeller pumps are ideally suited

to washdown, circulation and fire duty applications onboard or dockside. Where needed, these pumps have easily replaced cams, end covers and wearplates for extended product life.

For service and spare parts see pages 162-217. Flows quoted below at 1750 rpm & 10' (3m) vertical lift (suction head). Pumps are available with neoprene or, where oils may be encountered, nitrile.

51510 Series

- 2.3 GPM (10.5 LPM).
- Self-priming up to 11' (3.5m) vertical lift.
- Sealed bearings for longer life.
- Mechanical seal.

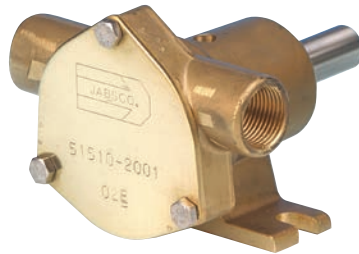

Replaces Johnson model F35B-8 (10-35038)

| | |
|----------------|---|
| FITTING | 3/8" (10mm) BSP internal thread |
| SIZE | 3-5/8" long x 3" wide x 2-3/8" high (9.2cm x 8cm x 6cm) |
| WEIGHT | 2lb (0.9kg) |

| MODEL | DESCRIPTION |
|------------|------------------|
| 51510-2001 | Pump |
| 51510-9001 | Pump, NPT thread |

51520 Series

- 4 GPM (18 LPM).
- Self-priming up to 13' (4.1m) vertical lift.
- Sealed bearings for longer life.
- Mechanical seal.

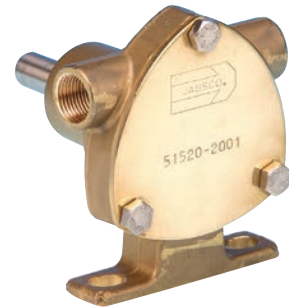

| | |
|----------------|---|
| FITTING | 3/8" (10mm) BSP internal thread |
| SIZE | 3-3/4" long x 3" wide x 3-1/2" high (9.5cm x 8cm x 8.5cm) |
| WEIGHT | 3lb (1.4kg) |

| MODEL | DESCRIPTION |
|------------|------------------|
| 51520-2001 | Pump |
| 51520-9001 | Pump, NPT thread |

2760 Series

- 3.7 GPM (14 LPM).
- Lip seal.
- Double row ball bearing.
- Self-priming up to 10' (3m) vertical lift.

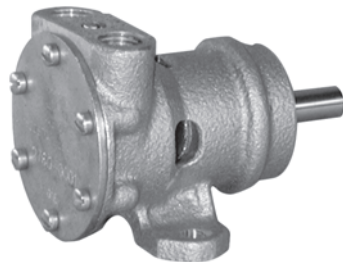

| | |
|----------------|---|
| FITTING | 1/4" (6mm) NPT |
| SIZE | 3-9/16" long x 1-3/8" wide x 2-7/16" high (9cm x 3.5cm x 6.2cm) |
| WEIGHT | 1.5lb (0.7kg) |

| MODEL | DESCRIPTION |
|-----------|---|
| 2760-0001 | Pump with neoprene impeller, full cam, lip seal |
| 2760-0003 | Pump with nitrile impeller, full cam, lip seal |

2620 Series

- 5.8 GPM (22 LPM).
- Lip seal.
- Two single row ball bearings.
- Self-priming up to 10' (3m) vertical lift.



| | |
|----------------|---|
| FITTING | 3/8" (10mm) NPT |
| SIZE | 3-15/16" long x 1-3/4" wide x 1-7/32" high (10cm x 4.4cm x 3.1cm) |
| WEIGHT | 2.75lb (1.3kg) |

| MODEL | DESCRIPTION |
|-----------|---|
| 2620-1101 | Pump with neoprene impeller, full cam, lip seal |
| 2620-1103 | Pump with nitrile impeller, full cam, lip seal |

5320-0011

- 5.8 GPM (22 LPM).
- Lip seal.
- Two single row ball bearings.
- Self-priming up to 10' (3m) vertical lift.

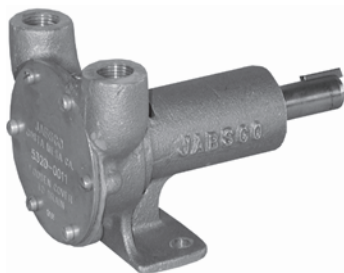

| | |
|----------------|--|
| FITTING | 3/8" (10mm) NPT |
| SIZE | 5-15/16" long x 3-1/2" wide x 3-5/16" high (15.1cm x 8.9cm x 8.4cm) |
| WEIGHT | 1.5lb (0.7kg) |

| MODEL | DESCRIPTION |
|-----------|---|
| 5320-0011 | Pump with neoprene impeller, full cam, lip seal |

1673 Series

- 11.3 GPM (43 LPM).
- Lip seal.
- Two single row ball bearings.
- Self-priming up to 10' (3m) vertical lift.



| | |
|----------------|---|
| FITTING | 1/2" (13mm) NPT |
| SIZE | 4-7/16" long x 4-1/8" wide x 3-13/16" high (11.3cm x 10.5cm x 9.7cm) |
| WEIGHT | 4.25lb (2kg) |

| MODEL | DESCRIPTION |
|-----------|---|
| 1673-1001 | Pump with neoprene impeller, full cam, lip seal |
| 1673-1003 | Pump with nitrile impeller, full cam, lip seal |

3890-9011

- 11.3 GPM (43 LPM).
- Mechanical face seal.
- Double row ball bearing.
- Self-priming up to 10' (3m) vertical lift.



| | |
|----------------|---|
| FITTING | 3/4" (19mm) NPT |
| SIZE | 5-3/16" long x 4" wide x 4" high (13.2cm x 10.2cm x 10.2cm) |
| WEIGHT | 4lb (1.8kg) |

| MODEL | DESCRIPTION |
|-----------|--|
| 3890-9011 | Pump with neoprene impeller, full cam, mechanical seal |

5330 Series

- 26 GPM (98 LPM).
- Mechanical face seal.
- Double row ball bearing.
- Self-priming up to 10' (3m) vertical lift.

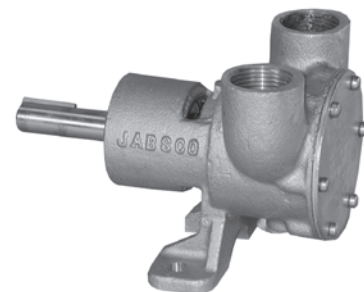

| | |
|----------------|--|
| FITTING | 1" (25mm) NPT |
| SIZE | 7" long x 4-3/4" wide x 4" high (17.8cm x 12.1cm x 10.2cm) |
| WEIGHT | 7lb (3.2kg) |

| MODEL | DESCRIPTION |
|-----------|--|
| 5330-9101 | Pump with neoprene impeller, full cam, mechanical seal |
| 5330-9001 | Pump with nitrile impeller, 2/3 cam, mechanical seal |

11 Flexible Impeller Pumps

PULLEY DRIVEN PUMPS



Original Jabsco Flexible Impeller Pumps are available with neoprene impellers for water (45-160°F, 8-70°C) and general purpose pumping and nitrile impellers which are ideal for oil-based products (50-160°F, 10-82°C). Head pressures up to 26 psi or 60' can be accommodated. For reduced flow, choose the half cam version. The choice of a mechanical seal extends pump life. Do not pump gasoline or other flammable liquids. Do not run dry.

For service and spare parts see pages 162-217. Quoted flows at 10' (3m) head and 1750 rpm.

777 Series

- 23 GPM (87 LPM).
- 10' (3m) dry prime, 22' (7m) wet prime.
- Bronze pedestal.

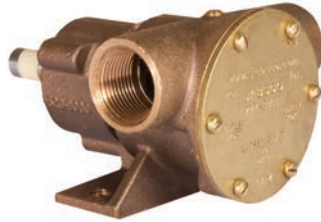

| | |
|----------------|---|
| FITTING | 1" (25mm) NPTF |
| SIZE | 3-9/16" long x 4-3/4" wide x 6-5/16" high (9cm x 12cm x 15.9cm) |
| WEIGHT | 5.8lb (2.6kg) |

VARIANT OPTIONS

| MODEL | IMPELLER | | CAM | | SEAL | |
|----------|----------|---------|------|------|------|------------|
| | NEOPRENE | NITRILE | FULL | HALF | LIP | MECHANICAL |
| 777-0001 | X | | X | | X | |
| 777-0003 | | X | X | | X | |
| 777-9001 | X | | X | | | X |
| 777-9003 | | X | X | | | X |
| 777-9051 | X | | | X | | X |

6400 Series

- 62 GPM (235 LPM).
- Double row ball bearing.
- 6400-1051 has short shaft for Caterpillar engines.
- Self-priming up to 10' (3m) vertical lift.



| | |
|----------------|---|
| FITTING | 1-1/4" (32mm) NPT |
| SIZE | 8-1/16" long x 5-7/8" wide x 4-7/8" high (20.5cm x 14.9cm x 12.4cm) |
| WEIGHT | 10.5lb (4.8kg) |

VARIANT OPTIONS

| MODEL | IMPELLER | | CAM | | SEAL | |
|-----------|----------|---------|------|------|------|------------|
| | NEOPRENE | NITRILE | FULL | HALF | LIP | MECHANICAL |
| 6400-0004 | X | | X | | | X |
| 6400-0051 | X | | | X | | X |
| 6400-1051 | X | | X | | | X |

7420 Series

- 62 GPM (235 LPM).
- Double row ball bearing.
- 7420-1001 has short shaft for Caterpillar engines.
- Self-priming up to 10' (3m) vertical lift.



| | |
|----------------|--|
| FITTING | 1-1/4" (32mm) NPT |
| SIZE | 8-1/16" long x 5-1/8" wide x 5-1/16" high (20.5cm x 13cm x 12.9cm) |
| WEIGHT | 10.5lb (4.8kg) |

VARIANT OPTIONS

| MODEL | IMPELLER | | CAM | | SEAL | |
|-----------|----------|---------|------|------|------|------------|
| | NEOPRENE | NITRILE | FULL | HALF | LIP | MECHANICAL |
| 7420-0004 | X | | X | | | X |
| 7420-1001 | X | | | X | | X |

18370-0000

- 83 GPM (314 LPM).
- Mechanical face seal.
- Neoprene or nitrile impeller.
- Two single row ball bearings.
- Self-priming up to 10' (3m) vertical lift.



| | |
|----------------|--|
| FITTING | 2" (51mm) NPT |
| SIZE | 10-7/8" long x 8" wide x 5-1/16" high (27.6cm x 20.3cm x 12.9cm) |
| WEIGHT | 19lb (8.6kg) |

| MODEL | DESCRIPTION |
|------------|--|
| 18370-0000 | Pump with neoprene impeller, full cam, mechanical seal |

Original Jabsco Flexible Impeller Pumps for commercial duty are fitted with proven quality mechanical seals, providing long life under exacting conditions. Bearings are spaced to allow higher speeds, without jeopardizing life, and the open design allows debris to pass through the pump without affecting flow or reliability. All Jabsco pumps are easily maintained using ordinary hand tools.

For service and spare parts see pages 162-217. Quoted flows at 10' (3m) head and 1500 rpm.

29860-2201

- 126 GPM (480 LPM).
- Self-priming up to 18' (5.5m) vertical lift.
- Special design for high flow rates.



| | |
|----------------|---|
| FITTING | 2-1/2" (64mm) BSP internal thread, 2-1/2" (64mm) flange |
| SIZE | 13" long x 9" wide x 9" high (33.2cm x 22.9cm x 22.9cm) |
| WEIGHT | 28lb (12.5kg) |

| MODEL | DESCRIPTION |
|------------|--------------------------|
| 29860-2201 | Pump with vertical ports |

52270-0011

- 60 GPM (270 LPM).
- Self-priming up to 15' (4.5m) vertical lift.



| | |
|----------------|---|
| FITTING | 2" (51mm) BSP internal thread, 2" (51mm) flange |
| SIZE | 11" long x 6" wide x 7" high (28cm x 17cm x 12.8cm) |
| WEIGHT | 20lb (5kg) |

| MODEL | DESCRIPTION |
|------------|-------------|
| 52270-0011 | Pump |

52580-9001

- 17.8 GPM (80 LPM).
- Self-priming up to 15' (4.5m) vertical lift.
- Space sealed for life bearings.
- Mechanical seal



| | |
|----------------|--|
| FITTING | 1" (25mm) BSP |
| SIZE | 6-1/2" long x 5" wide x 4" high (18cm x 12cm x 10cm) |
| WEIGHT | 5lb (2.1kg) |

| MODEL | DESCRIPTION |
|------------|-------------|
| 52580-9001 | Pump |

52220-0011

- 43.3 GPM (195 LPM).
- Self-priming up to 15' (4.5m) vertical lift.

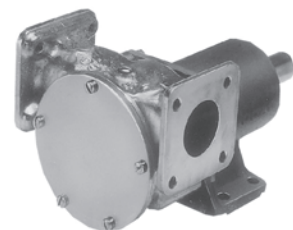

| | |
|----------------|---|
| FITTING | 1-1/2" (38mm) flange |
| SIZE | 10-1/2" long x 5" wide x 4" high (27.6cm x 15.2cm x 14.6cm) |
| WEIGHT | 16lb (7kg) |

| MODEL | DESCRIPTION |
|------------|-------------|
| 52220-0011 | Pump |

11 Flexible Impeller Pumps

PULLEY DRIVEN PUMPS



Flexible impeller pumps are self-priming and, therefore, ideal for engine cooling, washdown, circulation and many general purposes onboard or dockside. The bronze bodies and stainless steel shafts are well suited for marine environments. They can operate in either rotational direction. A variety of models are available with flows from 2.9 GPM (11 LPM) to 83 GPM (314 LPM) and with different port orientations to suit virtually any pumping

requirement. Most models have replaceable cams and wearplates for extended product life.

For service and spare parts see pages 162-217. Quoted flows at 10' (3m) head and 1500 rpm.

52200-2011

- 43.3 GPM (195 LPM).
- Self-priming up to 15' (4.5m) vertical lift.
- Double row angular contact bearing allows short length pump with medium duty rating.



| | |
|----------------|--|
| FITTING | 1-1/2" (38mm) BSP internal thread |
| SIZE | 8" long x 6" wide x 5" high (20.4cm x 15cm x 12cm) |
| WEIGHT | 11lb (5kg) |

| MODEL | DESCRIPTION |
|------------|-------------|
| 52200-2011 | Pump |

9710-200

- 17.8 GPM (80 LPM).
- Self-priming up to 15' (4.5m) vertical lift.
- 360° pump head orientation.
- Mechanical seal.



| | |
|----------------|---|
| FITTING | 1" (25mm) BSP internal thread |
| SIZE | 9" long x 5" wide x 3" high (22.9cm x 12cm x 8cm) |
| WEIGHT | 8lb (3.4kg) |

| MODEL | DESCRIPTION |
|----------|-------------|
| 9710-200 | Pump |

10550-200

- 8.8 GPM (40 LPM).
- Self-priming up to 18' (5.6m) vertical lift.
- 360° pump head orientation.
- Mechanical seal.



| | |
|----------------|---|
| FITTING | 3/4" (19mm) BSP internal thread |
| SIZE | 7" long x 4" wide x 3" high (17cm x 10.6cm x 7.6cm) |
| WEIGHT | 7lb (3kg) |

| MODEL | DESCRIPTION |
|--------------|--------------------|
| 10550-200 | Pump |

52040-2001

- 8.8 GPM (40 LPM).
- Self-priming up to 18' (5.6m) vertical lift.
- Double row angular contact bearing allows short length pump.
- Lip seal offers low cost reliability in medium duty environments.



| | |
|----------------|---|
| FITTING | 3/4" (19mm) BSP internal thread |
| SIZE | 5" long x 4" wide x 3" high (12.8cm x 10.6cm x 7.6cm) |
| WEIGHT | 3lb (1.5kg) |

| MODEL | DESCRIPTION |
|--------------|--------------------|
| 52040-2001 | Pump |

11 Flexible Impeller Pumps

UPGRADE TO JABSCO ENGINE COOLING PUMPS



As originators of the flexible impeller engine cooling pump, Jabsco is known worldwide for quality, reliability and serviceability.

As original equipment suppliers to engine marinizers, we also manufacture aftermarket alternatives to many original pumps. These pumps are designed to be fully serviceable, and after long use can be restored to like new condition, avoiding complete pump replacement.

DESIGNED FOR NORTH AMERICAN ENGINES

Jabsco 50410 Series

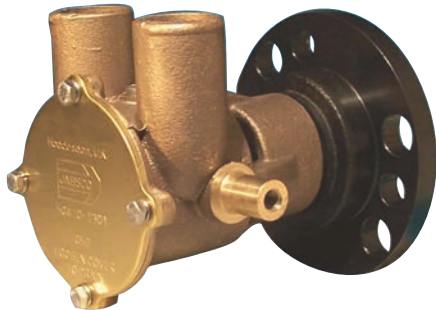

Probably the best crank shaft mounted pump available.

- Fits all major V8 engines.
- Lip or mechanical seals available.
- Specially designed impeller for longer life.
- Supercedes 22110 series pumps.

| | |
|----------------|---|
| FITTING | 1-1/4" (32mm) ID hose |
| SIZE | 50410-1201/1301: 5" long x 4-1/2" wide x 4-1/2" high (13cm x 11cm x 11cm) 50410-1251/1351: 5" long x 4-1/2" wide x 4-1/2" high (13cm x 11cm x 11cm) 50410-1401/1501: 4-1/2" long x 4-1/2" wide x 4-1/2" high (11cm x 11cm x 11cm) |
| WEIGHT | 5lb (2.2kg) |

| MODEL | DESCRIPTION |
|------------|---|
| 50410-1201 | 454 C.I. Chevrolet, lip seal |
| 50410-1301 | 454 C.I. Chevrolet, mechanical seal |
| 50410-1251 | 305 & 350 C.I. Chevrolet, lip seal |
| 50410-1351 | 305 & 350 C.I. Chevrolet, mechanical seal |
| 50410-1401 | 8.1L Chevrolet, lip seal |
| 50410-1501 | 8.1L Chevrolet, mechanical seal |

For service and spare parts listing, see pages 212-214.

MerCruiser Type 43210-0001

Marine engine cooling pump replaces MerCruiser model 46-72774-A32.

- Left or right hand rotation.
- One piece bronze body.
- Bronze end plate.
- Replaceable cam and wearplate.



| | |
|----------------|---|
| FITTING | 1-1/4" (32mm) hose barb |
| SIZE | 9-5/32" long x 4-1/2" wide x 4-1/8" high (23.3cm x 11cm x 10.5cm) |
| WEIGHT | 75lb (3.2kg) |
| DRIVE | Pulley |
| MOUNT | MerCruiser clamp type or MerCruiser bracket |

| MODEL | DESCRIPTION |
|------------|--|
| 43210-0001 | MerCruiser pump |
| 43216-1000 | Replacement bronze end cover for MerCruiser produced pumps |

For service and spare parts listing, see pages 208-210.

Crusader Type 42730-0000

Marine engine cooling pump replaces Crusader model number 97179 and Sherwood E-35.

- Fits most pre-1993 Crusader engines.
- Accepts Crusader drive pulley.
- Bolts directly to stock mounting bracket.
- Wearplate and seal can generally be replaced without removing the pump shaft.



| | |
|----------------|--|
| FITTING | 1" (25mm) NPT internal |
| SIZE | 4-15/16" long x 4-7/8" wide x 4-1/4" high (12.5cm x 12.4cm x 10.8cm) |
| WEIGHT | 7lb (3.2kg) |
| DRIVE | Pulley |
| MOUNT | Pedestal |

| MODEL | DESCRIPTION |
|------------|---------------|
| 42730-0000 | Crusader pump |

For service and spare parts listing, see page 208.

DESIGNED FOR NORTH AMERICAN ENGINES

Jabsco Replacements for Sherwood Engine Cooling Pumps

Jabsco Engine Cooling Pumps are constructed with all bronze body, bearing housing and stainless steel shaft to withstand harsh marine environments.

They can directly replace the Sherwood models G-30-2 on current Chris-Craft production engines and G-5 on current Chrysler engines. They may also fit some models of Volvo, Escort, Pleasurecraft and Datsun engines.

Pumps are available in a variety of configurations. They can be supplied with a choice of: 1" (25mm) or 1-1/4" (32mm) ports; mounting tabs on front or rear of bearing housing; and 6-1/2" (16.5cm) "A" belt pulley, pulley mounting adapter, or 3/16" (5mm) key on the shaft.

| JABSCO MODEL | SHERWOOD MODEL | PORT SIZE | ENGINE APPLICATION |
|--------------|----------------|---------------|---|
| 18830-0000 | G-30-2 | 1" (25mm) | Chris-Craft 350 C.I. |
| 18830-1020 | - | 1" (25mm) | Commander Marine 302, 351 C.I. Glastron 302, 351 C.I. 165, 190, 200 & 225 |
| 18840-0010 | G-21 | 1" (25mm) | Pleasurecraft |
| 18840-1010 | - | 1" (25mm) | Nisson LDM 4-cyl. |
| 18930-0000 | G-45-1 | 1-1/4" (32mm) | Chris-Craft |
| 18940-0010 | G-5, G-7-B | 1-1/4" (32mm) | Chrysler LM-318X- LM-340X Lehman 302, 351 C.I. Powerhouse Marine 302, 351 C.I. |

For service and spare parts listing, see page 190.

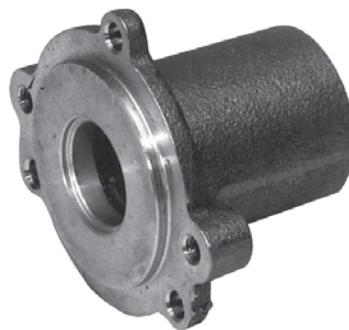

Mounting tabs near body



With pulley adapter



With pulley



With keyed shaft

Port size
1" 18830-0000
1-1/4" 18930-0000

Port size
1" 18830-0010
1-1/4" 18930-0010

Port size
1" 18830-1020
1-1/4" 18930-0020

17360-1001

Marine engine cooling pump for Caterpillar engine models. D-336 and D-353. With minor plumbing modifications may be adapted to:

- Caterpillar D-343.
- Detroit Diesel V-71 and V-92.
- Some Stewart and Stevenson marinizations of Detroit Diesel engines.

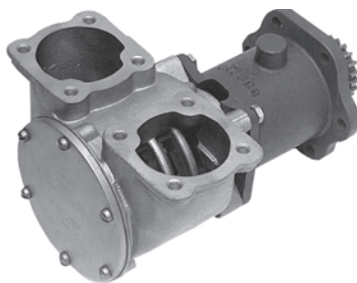

| | |
|----------------|--|
| FITTING | 2-1/2" (64mm) flange port |
| SIZE | 9-1/4" long x 7-7/8" wide x 5-15/16" high (23.5cm x 20cm x 15cm) |
| WEIGHT | 28lb (12.7kg) |
| DRIVE | Gear |
| MOUNT | Engine |

| MODEL | DESCRIPTION |
|------------|-------------|
| 17360-1001 | Pump |

For service and spare parts listing, see page 188.



Mounting tabs near pulley



With pulley

Port size
1" 18840-0010
1-1/4" 18940-0010
1-1/2" 18825-0010

11 Flexible Impeller Pumps

UPGRADE TO JABSCO ENGINE COOLING PUMPS



DESIGNED FOR NORTH AMERICAN ENGINES

5850-0001

Marine engine cooling pump for:

- Flagship.
- Palmer Lehman.
- Chris-Craft.

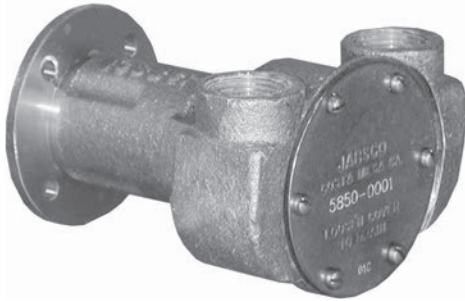

| | |
|----------------|---|
| FITTING | 3/4" (19mm) NPT |
| SIZE | 5-5/16" long x 4-1/4" wide x 3-1/4" high (13.5cm x 10.8cm x 8.3cm) |
| WEIGHT | 6lb (2.7kg) |
| DRIVE | Coupling |
| MOUNT | Engine |

For service and spare parts listing, see page 170.

12600-0001

Marine engine cooling pump for engine models:

- Cummins V-903.
- Cummins VT-903.

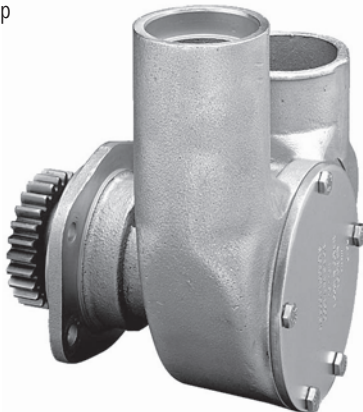

| | |
|----------------|--|
| FITTING | 3" (76mm) hose |
| SIZE | 7" long x 7-3/8" wide x 8-1/2" high (17.8cm x 18.7cm x 21.6cm) |
| WEIGHT | 20lb (9kg) |
| DRIVE | Gear |
| MOUNT | Engine |

For service and spare parts listing, see page 186.

7420-1001

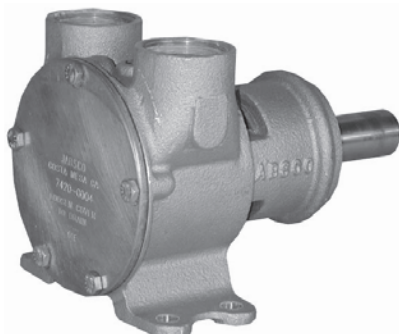

| | |
|----------------|---|
| FITTING | 1-1/4" (32mm) NPT vertical ports |
| SIZE | 7-1/32" long x 5-7/8" wide x 4-7/8" high (17.9cm x 14.9cm x 12.4cm) |
| WEIGHT | 10.5lb (4.8kg) |
| DRIVE | Pulley |
| MOUNT | Pedestal |

For service and spare parts listing, see page 174.

DESIGNED FOR NORTH AMERICAN ENGINES

6400-1051

Marine engine cooling pump for engine models:

- Caterpillar 3160.
- Caterpillar 3208.

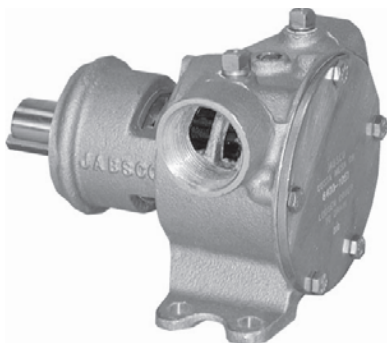

| | |
|----------------|---|
| FITTING | 1-1/4" (32mm) NPT horizontal ports |
| SIZE | 7-1/32" long x 5-7/8" wide x 4-7/8" high (17.9cm x 14.9cm x 12.4cm) |
| WEIGHT | 10.5lb (4.8kg) |
| DRIVE | Pulley |
| MOUNT | Pedestal |

For service and spare parts listing, see page 170.

18400-0050

Marine engine cooling generator pump for:

- Onan MDJF 15KW.

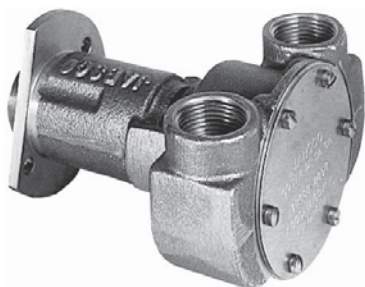

| | |
|----------------|--|
| FITTING | 3/4" (19mm) NPT |
| SIZE | 5-5/16" long x 4-1/4" wide x 3-1/4" high (13.5cm x 10.8cm x 8.3cm) |
| WEIGHT | 6lb (2.7kg) |
| DRIVE | Coupling |
| MOUNT | Engine |

For service and spare parts listing, see page 190.

3270-0001

Marine engine cooling pump for engine models:

- Perkins 4-107.
- Perkins 4-108.

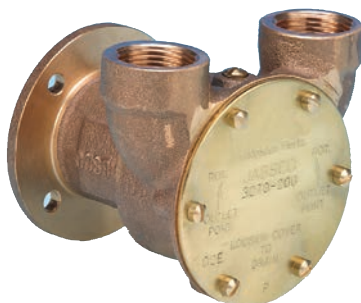

| | |
|----------------|---|
| FITTING | 3/4" (19mm) NPT |
| SIZE | 4-1/4" long x 4-1/8" wide x 3-7/8" high (10.8cm x 10.5cm x 9.8cm) |
| WEIGHT | 4lb (1.8kg) |
| DRIVE | Coupling |
| MOUNT | Engine |

For service and spare parts listing, see page 166.

11 Flexible Impeller Pumps

UPGRADE TO JABSCO ENGINE COOLING PUMPS



DESIGNED FOR EUROPEAN ENGINES

10950 Series

Marine engine cooling pump for Ford Dover and Dorset 4-cyl. engines. Marinized by:

- C-Power.
- CT Marine.
- Lancing.
- Lehman.
- SAAB.
- Sabre.
- Watermota.

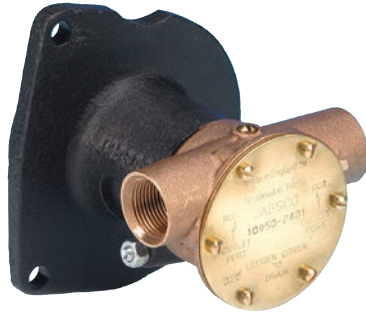

| | |
|----------------|--|
| FITTING | 3/4" (19mm) BSP |
| SIZE | 6-1/2" long x 4-1/2" wide x 5-1/8" high (16.6cm x 11.5cm x 13cm) |
| WEIGHT | 7lb (3kg) |
| DRIVE | Gear |
| MOUNT | Engine |

For service and spare parts listing, see pages 182-184.

21140 Series

Marine engine cooling pump for Ford Dover and Dorset 6-cyl. engines. Marinized by:

- C-Power.
- Hawker Siddeley Marine (Lister Petter).
- Lancing.
- Lehman.
- Mermaid.
- SAAB.
- Sabre.
- Tempest.
- Watermota.

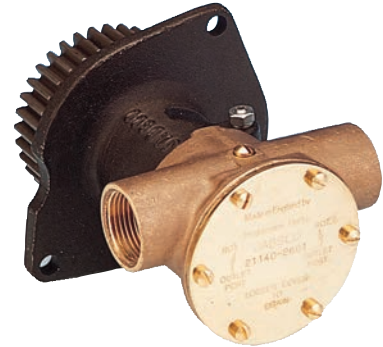

Also available in North America.

| | |
|----------------|--|
| FITTING | 1" (25mm) BSP |
| SIZE | 7-1/4" long x 4-1/2" wide x 5-1/8" high (18.5cm x 11.5cm x 13cm) |
| WEIGHT | 8lb (3.6kg) |
| DRIVE | Gear |
| MOUNT | Engine |

For service and spare parts listing, see page 192.

29500-1001

Marine engine cooling pump for:

- Aifo Iveco.
- Lancing.
- Perkins.
- Sole.
- VM Motori.

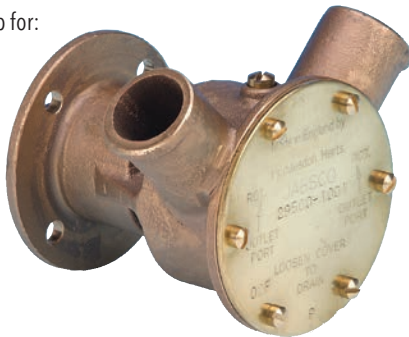

| | |
|----------------|---|
| FITTING | 1-1/8" (28mm) hose |
| SIZE | 4-3/4" long x 4" wide x 4" high (116cm x 10cm x 10cm) |
| WEIGHT | 2.5lb (1.2kg) |
| DRIVE | Coupling |
| MOUNT | Engine |

For service and spare parts listing, see page 204.

9700-01

Marine engine cooling pump for:

- Hamworthy.
- Perkins.
- Leyland-Thornycroft.

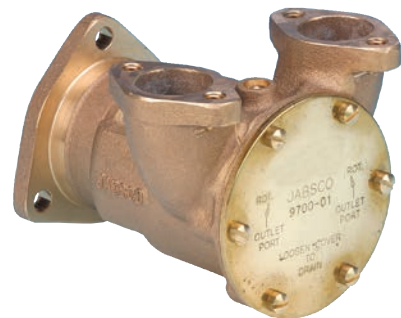

| | |
|----------------|---|
| FITTING | 1" (25mm) flanged |
| SIZE | 5-3/4" long x 4-3/4" wide x 3-7/8" high (14.9cm x 12.1cm x 9.9cm) |
| WEIGHT | 6lb (2.8kg) |
| DRIVE | Coupling |
| MOUNT | Engine |

For service and spare parts listing, see page 176.

DESIGNED FOR EUROPEAN ENGINES

9970-200

Marine engine cooling pump for:

- Hawker Siddeley Marine (Lister Petter).
- Hamworthy.
- Perkins.
- Lehman.
- Sisu (Valmet).



Also available in North America.

| | |
|----------------|---|
| FITTING | 3/4" (19mm) BSP |
| SIZE | 5-5/8" long x 4" wide x 3-3/8" high (14.3cm x 10cm x 8.6cm) |
| WEIGHT | 4lb (1.8kg) |
| DRIVE | Coupling |
| MOUNT | Engine |

For service and spare parts listing, see page 176.

10970

Marine engine cooling pump for:

- Perkins 4.236.

Also available in North America.



| | |
|----------------|--|
| FITTING | 3/4" (19mm) NPTF |
| SIZE | 5-5/8" long x 4-3/4" wide x 4-1/2" high (14.3cm x 12cm x 11.5cm) |
| WEIGHT | 7lb (3.26kg) |
| DRIVE | Gear |
| MOUNT | Engine |

For service and spare parts listing, see page 184.

10970-21

Marine engine cooling pump for:

- Perkins 4.236.
- Perkins M90.

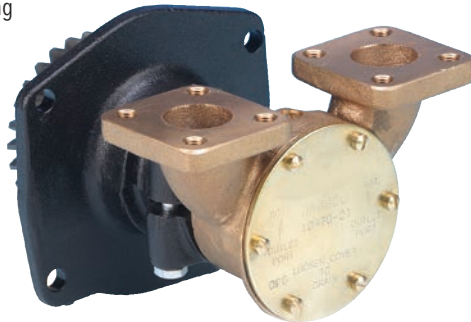

| | |
|----------------|--|
| FITTING | 3/4" (19mm) flanged |
| SIZE | 5-7/8" long x 5-5/8" wide x 4-1/2" high (14.9cm x 14.3cm x 11.5cm) |
| WEIGHT | 8lb (3.6kg) |
| DRIVE | Gear |
| MOUNT | Mount |

For service and spare parts listing, see page 184.

11 Flexible Impeller Pumps

COOLING PUMP SPARES BY MAKE OF ENGINE



| JABSCO PUMP DETAILS | | | | | | | SERVICE KIT DETAILS | | | | |
|----------------------------|-------------------------|------|----------------|------------|----------|-----------------------|---------------------|------------------|------------|-------------|------------------|
| MODEL NUMBER | MODEL NUMBER * OEM ONLY | SIZE | PORT SIZE | MOUNT TYPE | OBSOLETE | ALTERNATE PUMP NUMBER | NUMBER | END COVER GASKET | IMPELLER | WATER SEAL | END COVER SCREWS |
| AIFO IVECO – ITALY | | | | | | | | | | | |
| C78 ENT M55.10 | 11100-0541 | 270 | 2" Flanged | Flange | | | SK254 | 816 | 21676-0001 | 21849 | SP1005-04 |
| CO 1DM / 2DM / 3DM | 9700-41 | 080 | 1" Flanged | Flange | • | 9700-01 + CAM 2431 | SK238-21 | 2432 | 17937-0001 | SP6080-06 | SP1003-01 |
| | 29500-1001 | 040 | Ø 28 Hose | Flange | | | SK384-0001 | 3298 | 1210-0001 | SP2700-1027 | SP1002-02 |
| | 29500-1001 | 040 | Ø 28 Hose | Flange | | | SK384-0001 | 3298 | 1210-0001 | SP2700-1027 | SP1002-02 |
| CP 3SM | 9700-21 | 080 | 1" Flanged | Flange | | 29600-1001 | SK238 | 890 | 17937-0001 | SP6080-06 | SP1003-01 |
| | 29600-1001 | 080 | Ø 32 Hose | Flange | | New Pipework | SK385-0101 | 890 | 17937-0001 | SP6080-0469 | SP1003-0111 |
| OMCP 3M | 9700-21 | 080 | 1" Flanged | Flange | | 29600-1001 | SK238 | 890 | 17937-0001 | SP6080-06 | SP1003-01 |
| | 29600-1001 | 080 | Ø 32 Hose | Flange | | New Pipework | SK385-0101 | 890 | 17937-0001 | SP6080-0469 | SP1003-0111 |
| UNO M20 | 22770-1051 | 060 | Ø 25 Hose | Crank | • | 29440-1051 | SK346 | 1985-01 | 673-0001 | SP2701-21 | SP1004-09 |
| UNO M40 | 22770-1051 | 060 | Ø 25 Hose | Crank | • | 29440-1051 | SK346 | 1985-01 | 673-0001 | SP2701-21 | SP1004-09 |
| | 29440-1051 | 020 | Ø 25 Hose | Crank | | | SK402-0001 | 1985-0000 | 18653-0001 | 29441-0000 | SP1004-09 |
| 503 / 504 / 505 / 513 | 9700-61 | 080 | 1" Flanged | Flange | • | | SK238 | 890 | 17937-0001 | SP6080-06 | SP1003-01 |
| 520S / 521 / 521S | 9700-61 | 080 | 1" Flanged | Flange | • | | SK238 | 890 | 17937-0001 | SP6080-06 | SP1003-01 |
| 514 / 600 | 9560 | 010 | 3/8" BSP | Flange | • | | SK23 | 1189 | 4528-0001 | SP2701-14 | SP1002-01 |
| | 29500-1001 | 040 | Ø 28 Hose | Flange | | | SK384-0001 | 3298 | 1210-0001 | SP2700-1027 | SP1002-02 |
| 806 SM | 9700-21 | 080 | 1" Flanged | Flange | | 29600-1001 | SK238 | 890 | 17937-0001 | SP6080-06 | SP1003-01 |
| 8060 M / SDM | 9700-21 | 080 | 1" Flanged | Flange | | 29600-1001 | SK238 | 890 | 17937-0001 | SP6080-06 | SP1003-01 |
| 8061SM / SRM | 9700-21 | 080 | 1" Flanged | Flange | | 29600-1001 | SK238 | 890 | 17937-0001 | SP6080-06 | SP1003-01 |
| | 29600-1001 | 080 | Ø 32 Hose | Flange | | New Pipework | SK385-0101 | 890 | 17937-0001 | SP6080-0469 | SP1003-0111 |
| 8141 M / SRM | 9700-21 | 080 | 1" Flanged | Flange | | 29600-1001 | SK238 | 890 | 17937-0001 | SP6080-06 | SP1003-01 |
| | 29600-1001 | 080 | Ø 32 Hose | Flange | | New Pipework | SK385-0101 | 890 | 17937-0001 | SP6080-0469 | SP1003-0111 |
| 8141SM11 | 29500-1001 | 040 | Ø 28 Hose | Flange | | | SK384-0001 | 3298 | 1210-0001 | SP2700-1027 | SP1002-02 |
| 821 / 8210 / 8220 / 8280 M | 9700-21 | 080 | 1" Flanged | Flange | | 29600-1001 | SK238 | 890 | 17937-0001 | SP6080-06 | SP1003-01 |
| 8210 M | 9700-21 | 080 | 1" Flanged | Flange | | 29600-1001 | SK238 | 890 | 17937-0001 | SP6080-06 | SP1003-01 |
| | 29600-1001 | 080 | Ø 32 Hose | Flange | | New Pipework | SK385-0101 | 890 | 17937-0001 | SP6080-0469 | SP1003-0111 |
| 8280 M / 8281 SRM | 23340-1001 | 120 | Ø 45 Hose | Flange | • | | SK310 | 890 | 17018-0001 | 22617-0010 | SP1003-09 |
| 8281 SRM 44 / 47 / 70 | 11100-0541 | 270 | 2" Flanged | Flange | | | SK254 | 816 | 21676-0001 | 21849 | SP1005-04 |
| 828 MTEA | 10880-2611 | 200 | 1-1/2" Flanged | Flange | • | | SK375-0101 | 816 | 17935-0001 | 21849 | SP1005-04 |

| JABSCO PUMP DETAILS | | | | | | | SERVICE KIT DETAILS | | | | |
|---------------------|-------------------------|------|----------------|------------|----------|-----------------------|---------------------|------------------|------------|-------------|------------------|
| MODEL NUMBER | MODEL NUMBER * OEM ONLY | SIZE | PORT SIZE | MOUNT TYPE | OBSOLETE | ALTERNATE PUMP NUMBER | NUMBER | END COVER GASKET | IMPELLER | WATER SEAL | END COVER SCREWS |
| | 10880-2561 | 200 | 1-1/2" Flanged | Flange | | | SK375-0101 | 816 | 17935-0001 | 21849 | SP1005-04 |
| 91 SRM / 12L | 29850-0031 | 370 | 2-3/4" Flanged | Flange | • | 29880-0001 | SK410 | X4020-424A | 17420-0001 | 21849 | SP1094-0060 |
| | 29880-0001 | 370 | 2-3/4" Flanged | Flange | | | SK410 | X4020-424A | 17240-0001 | 21849 | X3001-180F |
| 836 MTCA | 9700-21 | 080 | 1" Flanged | Flange | | 29600-1001 | SK238 | 890 | 17937-0001 | SP6080-06 | SP1003-01 |
| 8361 M / SM / SRM | 9700-21 | 080 | 1" Flanged | Flange | | 29600-1001 | SK238 | 890 | 17937-0001 | SP6080-06 | SP1003-01 |
| | 29600-1001 | 080 | Ø 32 Hose | Flange | | New Pipework | SK385-0101 | 890 | 17937-0001 | SP6080-0469 | SP1003-0111 |
| 8460 SRM 45 / 50 | 11100-0541 | 270 | 2" Flanged | Flange | | | SK254 | 816 | 21676-0001 | 21849 | SP1005-04 |
| 402IM17 | 29470-2231C | 020 | 3/8" BSP | Flange | | | SK405-0001 | 29476-0000 | 18653-0001 | SP2701-1006 | X3004-095G |
| 403IM25 | 29470-2531C | 020 | 3/8" BSP | Flange | | | SK405-0001 | 29476-0000 | 18653-0001 | SP2701-1006 | X3004-095G |
| 404IM33 | 29470-2431C | 020 | 3/8" BSP | Flange | | | SK405-0001 | 29476-0000 | 18653-0001 | SP2701-1006 | X3004-095G |
| 414IM48 | 29470-2431C | 020 | 3/8" BSP | Flange | | | SK405-0001 | 29476-0000 | 18653-0001 | SP2701-1006 | X3004-095G |
| M37.10 | 50350-1101 | 120 | Ø 45 Hose | Flange | | | | X4020-269A | 17018-0001 | SP6080-0469 | X3001-176F |

AMERICAN DIESEL – USA

| | | | | | | | | | | | |
|------------------|------------|-----|----------|--------|--|--|-------|------|------------|------------|-----------|
| Ford (UK) 4-cyl. | 10950-2401 | 040 | 3/4" BSP | Flange | | | SK239 | 3298 | 1210-0001 | 22617-0010 | SP1002-02 |
| Ford (UK) 6-cyl. | 21140-2401 | 080 | 1" BSP | Flange | | | SK229 | 890 | 17937-0001 | 22617-0010 | SP1003-09 |

BAUDOUIIN – FRANCE

| | | | | | | | | | | | |
|--------|------------|-----|-----------|--------|--|--|------------|-----|------------|-------------|-------------|
| GD 106 | 23430-1301 | 080 | Ø 32 Hose | Flange | | | SK385-0001 | 890 | 17937-0001 | SP2700-1027 | SP1003-0111 |
|--------|------------|-----|-----------|--------|--|--|------------|-----|------------|-------------|-------------|

BETA MARINE – UK

| | | | | | | | | | | | |
|----------------------------|------------|-----|-----------|--------|---|------------|------------|-----------|------------|-------------|-------------|
| Isuzu - B3KC1 | 29460-1001 | 020 | Ø 20 Hose | Flange | • | | SK401-0001 | 2995-0030 | 18653-0001 | SP2701-1006 | SP1002-01 |
| BD3 | 23430-1251 | 080 | Ø 32 Hose | Flange | • | | SK385-0001 | 890 | 17937-0001 | SP2700-1027 | SP1003-0111 |
| BD4 | 21140-2601 | 080 | 1" BSP | Flange | | | SK229 | 890 | 17937-0001 | 22617-0010 | SP1003-09 |
| BZ482 | 29460-1401 | 020 | Ø 20 Hose | Flange | • | 29460-1631 | SK401-0001 | 2995-0030 | 18653-0001 | SP2701-1006 | SP1002-01 |
| BD662 / 772 | 29460-1401 | 020 | Ø 20 Hose | Flange | • | 29460-1631 | SK401-0001 | 2995-0030 | 18653-0001 | SP2701-1006 | SP1002-01 |
| BD1005 | 29460-1301 | 020 | Ø 20 Hose | Flange | • | 29460-1701 | SK401-0001 | 2995-0030 | 18653-0001 | SP2701-1006 | SP1002-01 |
| BV1205 / 1305 / 1505 | 29460-1301 | 020 | Ø 20 Hose | Flange | • | 29460-1701 | SK401-0001 | 2995-0030 | 18653-0001 | SP2701-1006 | SP1002-01 |
| BV1903 / 2203 | 29500-1501 | 020 | Ø 20 Hose | Flange | | | SK401-0001 | 2995-0030 | 18653-0001 | SP2701-1006 | SP1002-01 |
| BF2803 | 29500-1501 | 020 | Ø 20 Hose | Flange | | | SK401-0001 | 2995-0030 | 18653-0001 | SP2701-1006 | SP1002-01 |
| Kubota-Series BZ / BD / BV | 29460-1401 | 020 | Ø 20 Hose | Flange | • | 29460-1631 | SK401-0001 | 2995-0030 | 18653-0001 | SP2701-1006 | SP1002-01 |

11 Flexible Impeller Pumps

COOLING PUMP SPARES BY MAKE OF ENGINE



| JABSCO PUMP DETAILS | | | | | | | SERVICE KIT DETAILS | | | | |
|-------------------------------------|-------------------------|------|-----------|------------|----------|-----------------------|---------------------|------------------|------------|-------------|------------------|
| MODEL NUMBER | MODEL NUMBER * OEM ONLY | SIZE | PORT SIZE | MOUNT TYPE | OBSOLETE | ALTERNATE PUMP NUMBER | NUMBER | END COVER GASKET | IMPELLER | WATER SEAL | END COVER SCREWS |
| BUKH-KALUNDBORG | | | | | | | | | | | |
| DV 8 ME / SME | 29300-2101C | 010 | 3/8" BSP | Flange | • | | SK404-0001 | 29308-0000 | 22405-0001 | SP2701-1006 | X3004-095G |
| DV 10 L / LME / LSME | 29300-2101C | 010 | 3/8" BSP | Flange | • | | SK404-0001 | 29308-0000 | 22405-0001 | SP2701-1006 | X3004-095G |
| DV 10 M | 11260-2151 | 010 | 3/8" BSP | Flange | • | 29300-2151C | SK266 | 1126 | 4528-0001 | SP2701-04 | SP1002-01 |
| DV 10 ME / SME | 29300-2101C | 010 | 3/8" BSP | Flange | • | | SK404-0001 | 29308-0000 | 22405-0001 | SP2701-1006 | X3004-095G |
| DV 20 M | 11260-2101 | 010 | 3/8" BSP | Flange | • | 29300-2201C | SK266 | 1126 | 4528-0001 | SP2701-04 | SP1002-01 |
| DV 20 M | 29300-2201C | 010 | 3/8" BSP | Flange | • | | SK404-0001 | 29308-0000 | 22405-0001 | SP2701-1006 | X3004-095G |
| DV 20 ME / SME | 29300-2101C | 010 | 3/8" BSP | Flange | • | | SK404-0001 | 29308-0000 | 22405-0001 | SP2701-1006 | X3004-095G |
| DV 24 ME / SME | 29300-2101C | 010 | 3/8" BSP | Flange | • | | SK404-0001 | 29308-0000 | 22405-0001 | SP2701-1006 | X3004-095G |
| DV 36 ME / SME | 29300-2101C | 040 | 3/8" BSP | Flange | • | | SK404-0001 | 29308-0000 | 22405-0001 | SP2701-1006 | X3004-095G |
| 2G/3G 105M | 10-32256-1 | 040 | | | | | | | 1210-0001 | | |
| 4K 105 M | 9710-205 | 080 | 1" BSP | Foot | | | SK229-01 | 2432 | 17937-0001 | 22617-0010 | SP1003-09 |
| 6K 105 M | 9710-204 | 080 | 1" BSP | Foot | • | | SK229 | 890 | 17937-0001 | 22617-0010 | SP1003-09 |
| BUROLI – ITALY | | | | | | | | | | | |
| Escort XLD | 52040-2001 | 040 | 3/4" BSP | Foot | | | SK384-0101 | 3298 | 1210-0001 | SP2701-1015 | X3001-095F |
| Ford 2401E | 10950-201 | 040 | 1/2" BSP | Flange | • | 10950-2401 | SK239 | 3298 | 1210-0001 | 22617-0010 | SP1002-02 |
| Ford 2401E | 10950-2401 | 040 | 3/4" BSP | Flange | | | SK239 | 3298 | 1210-0001 | 22617-0010 | SP1002-02 |
| Ford 2725 / 2726 TM | 21140-2601 | 080 | 1" BSP | Flange | | | SK229 | 890 | 17937-0001 | 22617-0010 | SP1003-09 |
| Ford 2728 TIM | 21140-2601 | 080 | 1" BSP | Flange | | | SK229 | 890 | 17937-0001 | 22617-0010 | SP1003-09 |
| CATERPILLAR MARINE POWER LTD | | | | | | | | | | | |
| 3.323 / 329 | 21090-204 | 040 | 3/4" BSP | Flange | • | | SK230 | 816 | 836-0001 | 21849 | SP1005-04 |
| 3.333 / 333 H | 21090-204 | 040 | 3/4" BSP | Flange | • | | SK230 | 816 | 836-0001 | 21849 | SP1005-04 |
| 4.18 | 6490-223 | 040 | 1/2" BSP | Foot | • | | SK225-01 | 6496 | 1210-0001 | SP2701-21 | SP1003-09 |
| 4.90 | 52040-2001 | 040 | 3/4" BSP | Foot | | | SK384-0101 | 3298 | 1210-0001 | SP2701-1015 | X3001-095F |
| 4.120 | 29500-1001 | 040 | Ø 28 Hose | Flange | | | SK384-0001 | 3298 | 1210-0001 | SP2700-1027 | SP1002-02 |
| 4.220 | 6490-223 | 040 | 1/2" BSP | Foot | • | | SK225-01 | 6496 | 1210-0001 | SP2701-21 | SP1003-09 |
| 4.254 | 10950-2441 | 040 | 3/4" BSP | Flange | • | 10950-2601 | SK239 | 3298 | 1210-0001 | 22617-0010 | SP1002-02 |
| 4.254 | 10950-2601 | 040 | 3/4" BSP | Flange | | | SK239 | 3298 | 1210-0001 | 22617-0010 | SP1002-02 |
| 4.254 | 21140-2401 | 080 | 1" BSP | Flange | | | SK229 | 890 | 17937-0001 | 22617-0010 | SP1003-09 |
| 4.442 | 21090-204 | 040 | 3/4" BSP | Flange | • | | SK230 | 816 | 836-0001 | 21849 | SP1005-04 |

| JABSCO PUMP DETAILS | | | | | | | SERVICE KIT DETAILS | | | | |
|--------------------------|-------------------------|------|----------------|------------|----------|-----------------------|---------------------|------------------|------------|-------------|------------------|
| MODEL NUMBER | MODEL NUMBER * OEM ONLY | SIZE | PORT SIZE | MOUNT TYPE | OBSOLETE | ALTERNATE PUMP NUMBER | NUMBER | END COVER GASKET | IMPELLER | WATER SEAL | END COVER SCREWS |
| 4.444 | 23430-1201 | 080 | Ø 32 Hose | Flange | | | SK385-0001 | 890 | 17937-0001 | SP2700-1027 | SP1003-0111 |
| 6.216 | 21140-2401 | 080 | 1" BSP | Flange | | | SK229 | 890 | 17937-0001 | 22617-0010 | SP1003-09 |
| 6.363 TC / TC 1C | 21140-200 | 080 | 1" BSP | Flange | • | 21140-2401 | SK229 | 890 | 17937-0001 | 22617-0010 | SP1003-09 |
| 6.363 TC / TC 1C | 21140-2401 | 080 | 1" BSP | Flange | | | SK229 | 890 | 17937-0001 | 22617-0010 | SP1003-09 |
| 6.380 | 21140-200 | 080 | 1" BSP | Flange | • | 21140-2401 | SK229 | 890 | 17937-0001 | 22617-0010 | SP1003-09 |
| 6.380 | 21140-2401 | 080 | 1" BSP | Flange | | | SK229 | 890 | 17937-0001 | 22617-0010 | SP1003-09 |
| 6.666 | 23430-1201 | 080 | Ø 32 Hose | Flange | | | SK385-0001 | 890 | 17937-0001 | SP2700-1027 | SP1003-0111 |
| 6.78 LTT I | 29700-1201 | 120 | Ø 45 Hose | Flange | | | SK386-0001 | 890 | 17018-0001 | SP6080-0469 | SP1003-0111 |
| Ford 2500 | 23430-1201 | 080 | Ø 32 Hose | Flange | | | SK385-0001 | 890 | 17937-0001 | SP2700-1027 | SP1003-0111 |
| Ford 2720 | 21140-2401 | 080 | 1" BSP | Flange | | | SK229 | 890 | 17937-0001 | 22617-0010 | SP1003-09 |
| CRM – ITALY | | | | | | | | | | | |
| 9 D / A / S | 10590 | 270 | 2" Flanged | Flange | • | 10590-22 | SK254 | 816 | 21676-0001 | 21849 | SP1005-04 |
| | 10590-22 | 270 | 2" Flanged | Flange | • | 2 Pumps/ Eng. | SK254 | 816 | 21676-0001 | 21849 | SP1005-04 |
| 12 / 18 DS2 | 9700-131 | 080 | 1" Flanged | Flange | | | SK238 | 890 | 17937-0001 | SP6080-06 | SP1003-01 |
| CUMMINS – UK | | | | | | | | | | | |
| NH 250M | 3570 | 200 | 1-3/4" Flanged | Flange | • | | SK375-0101 | 816 | 17935-0001 | 21849 | SP1005-04 |
| NT 855M | 7420-0101 | 200 | 1-1/4" NPT | Foot | | | SK375-0101 | 816 | 17935-0001 | 21849 | SP1005-04 |
| V504M | 11600 | 080 | 1" NPT | Foot | • | | SK299 | 890 | 17937-0001 | 22617-0010 | SP1003-09 |
| V555M SC | 21680-05 | 080 | 1-1/4" NPT | Foot | • | | SK315-0101 | 816 | 17935-0001 | 21849 | SP1005-04 |
| VT555M SC | 21680-05 | 080 | 1-1/4" NPT | Foot | • | | SK315-0101 | 816 | 17935-0001 | 21849 | SP1005-04 |
| VT55M BC | 7420-0004 | 200 | 1-1/4" NPT | Foot | • | 7420-0101 | SK375-0101 | 816 | 17935-0001 | 21849 | SP1005-04 |
| VT55M BC | 7420-0101 | 200 | 1-1/4" NPT | Foot | | | SK375-0101 | 816 | 17935-0001 | 21849 | SP1005-04 |
| VT555M BC | 7420-0101 | 200 | 1-1/4" NPT | Foot | | | SK375-0101 | 816 | 17935-0001 | 21849 | SP1005-04 |
| B-Series | 23430-1401 | 080 | Ø 32 Hose | Flange | | | SK385-0001 | 890 | 17937-0001 | SP2700-1027 | SP1003-0111 |
| | | | | | | Sherwood Pump | | | 18948-0001 | | |
| DAF – NETHERLANDS | | | | | | | | | | | |
| DA 475 / D 575 M | 6420-2001 | 080 | 1" BSP | Foot | • | 52080-2001 | SK385-0201 | 890 | 17937-0001 | SP2700-1027 | SP1003-09 |
| DA 475 / D 575 M | 52080-2001 | 080 | 1" BSP | Foot | | | SK406-0001 | 890 | 17937-0001 | SP2700-48 | X3001-147F |

11 Flexible Impeller Pumps

COOLING PUMP SPARES BY MAKE OF ENGINE



| JABSCO PUMP DETAILS | | | | | | | SERVICE KIT DETAILS | | | | |
|---------------------------------|-------------------------|------|----------------|------------|----------|-----------------------|---------------------|------------------|------------|-------------|------------------|
| MODEL NUMBER | MODEL NUMBER * OEM ONLY | SIZE | PORT SIZE | MOUNT TYPE | OBSOLETE | ALTERNATE PUMP NUMBER | NUMBER | END COVER GASKET | IMPELLER | WATER SEAL | END COVER SCREWS |
| DS 575 M | 9710-200 | 080 | 1" BSP | Foot | | | SK229 | 890 | 17937-0001 | 22617-0010 | SP1003-09 |
| DT 575 MY | 11410-200 | 040 | 3/4" BSP | Foot | • | Bilge | SK328 | 11415 | 1210-0001 | 22617-0010 | SP1003-08 |
| | Dual Pump | 080 | 1" BSP | Foot | | Cooling | SK328 | 890 | 17937-0001 | 22617-0010 | SP1003-11 |
| DT 615 MY | 9710-200 | 080 | 1" BSP | Foot | | | SK229 | 890 | 17937-0001 | 22617-0010 | SP1003-09 |
| D 600 | 11100-0151 | 270 | 2" Flanged | Flange | • | | SK254 | 816 | 21676-0001 | 21849 | SP1005-04 |
| D 620 | 10630-57 | 200 | 1-1/2" Flanged | Flange | • | 52220-0011 | SK230 | 816 | 836-0001 | 21849 | SP1005-04 |
| D 620 | 52220-0051 | 200 | 1-1/2" Flanged | Foot | | | SK407-0011 | 816 | 17935-0001 | SP6080-0374 | X3001-176F |
| DP 680 M | 9710-200 | 080 | 1" BSP | Foot | | | SK229 | 890 | 17937-0001 | 22617-0010 | SP1003-09 |
| DP 680 M | 11410-200 | 040 | 3/4" BSP | Foot | • | Bilge | SK328 | 11415 | 1210-0001 | 22617-0010 | SP1003-08 |
| | Dual Pump | 080 | 1" BSP | Foot | | Cooling | SK328 | 890 | 17937-0001 | 22617-0010 | SP1003-11 |
| DK 1160 MY | 10770-57 | 200 | 1-1/2" Flanged | Flange | | | SK230 | 816 | 836-0001 | 21849 | SP1005-04 |
| DKS 1160 M | 11100-0101 | 270 | 2" Flanged | Flange | • | | SK254 | 816 | 21676-0001 | 21849 | SP1005-04 |
| DKT 1160 | 11100-0141 | 270 | 2" Flanged | Flange | • | | SK254 | 816 | 21676-0001 | 21849 | SP1005-04 |
| DAYTONA – USA | | | | | | | | | | | |
| DME - 4 | 30892-0001 | | | | | | | | | | |
| DME - 6 | 30892-0001 | | | | | | | | | | |
| DME - 7 (to mid-1995) | 17360-1001 | | | | | | 90190-0001 | 17365-1000 | 17365-0001 | 996080-0371 | 91005-0040 |
| DME - 7 (from mid-1995) | 17490-0001 | | | | • | | | | | | |
| DME - 9 (to mid-1995) | 17360-1001 | | | | | | 90190-0001 | 17365-1000 | 17365-0001 | 996080-0371 | 91005-0040 |
| DME - 9 (from mid-1995) | 17490-0001 | | | | • | | | | | | |
| DRINKWAARD – NETHERLANDS | | | | | | | | | | | |
| DAF D-Series | | | | | | | | | | | |
| A 475 / D 575 / F 615 | 6420-2001 | 080 | 1" BSP | Foot | • | 52080-2001 | SK385-0201 | 890 | 17937-0001 | SP2700-1027 | SP1003-09 |
| A 475 / D 575 / F 615 | 52080-2001 | 080 | 1" BSP | Foot | | | SK406-0001 | 890 | 17937-0001 | SP2700-48 | X3001-147F |
| Mercedes | | | | | | | | | | | |
| OM 314 / 352 / 352A | 6420-2001 | 080 | 1" BSP | Foot | • | 52080-2001 | SK385-0201 | 890 | 17937-0001 | SP2700-1027 | SP1003-09 |
| OM 314 / 352 / 352A | 52080-2001 | 080 | 1" BSP | Foot | | | SK406-0001 | 890 | 17937-0001 | SP2700-48 | X3001-147F |
| OM 615 / 621 / 636 | 3270-2301 | 040 | 3/4" BSP | Flange | • | | SK33 | 3298 | 1210-0001 | SP2701-21 | SP1002-02 |
| OM 616 / 617 | 23430-1601 | 080 | Ø 32 Hose | Flange | | | SK385-0001 | 890 | 17937-0001 | SP2700-1027 | SP1003-0111 |
| Mitsubishi | | | | | | | | | | | |
| KE 75 | 3270-2301 | 040 | 3/4" BSP | Flange | • | | SK33 | 3298 | 1210-0001 | SP2701-21 | SP1002-02 |

| JABSCO PUMP DETAILS | | | | | | | SERVICE KIT DETAILS | | | | |
|----------------------------------|-------------------------|------|-----------|------------|----------|-----------------------|---------------------|------------------|------------|-------------|------------------|
| MODEL NUMBER | MODEL NUMBER * OEM ONLY | SIZE | PORT SIZE | MOUNT TYPE | OBSOLETE | ALTERNATE PUMP NUMBER | NUMBER | END COVER GASKET | IMPELLER | WATER SEAL | END COVER SCREWS |
| K 3D / 4C | 3270-2301 | 040 | 3/4" BSP | Flange | • | | SK33 | 3298 | 1210-0001 | SP2701-21 | SP1002-02 |
| K 2AS | 52010-2001 | 010 | 3/8" NPTF | Foot | • | 51510-2001 | SK404-0101 | 29308-0000 | 22405-0001 | SP2701-0501 | X3001-095F |
| DUFFIELD – UK | | | | | | | | | | | |
| MC 42 | 29450-1231 | 020 | Ø 20 Hose | Flange | | | SK387-0001 | 2995-0030 | 673-0001 | SP2700-05 | SP1002-01 |
| 3HD 46 | 29450-1201 | 020 | Ø 20 Hose | Flange | | | SK387-0001 | 2995-0030 | 673-0001 | SP2700-05 | SP1002-01 |
| ENTEC WEST – USA | | | | | | | | | | | |
| K 34 | 29300-2401 | 010 | 3/8" BSP | Flange | • | | SK404-0001 | 29308-0000 | 22405-0001 | SP2701-1006 | X3004-095G |
| FARYMANN DIESEL – GERMANY | | | | | | | | | | | |
| A 30M / H | 11620-211 | 010 | 1/4" BSP | Flange | • | | SK23 | 1189 | 4528-0001 | SP2701-11 | SP1002-01 |
| A 30 | | | | | | Johnson Pump | | | 22405-0001 | | |
| A 40M / H | 11620-211 | 010 | 1/4" BSP | Flange | • | | SK23 | 1189 | 4528-0001 | SP2701-11 | SP1002-01 |
| AL 35 | | | | | | Johnson Pump | | | 22405-0001 | | |
| AL 40 | | | | | | Johnson Pump | | | 22405-0001 | | |
| CS | 6540-201 | 020 | 3/8" BSP | Foot | • | | SK205-01 | 2995-0030 | 673-0001 | B22 | SP8019-01 |
| CS | 2620-211 | 020 | 3/8" BSP | Foot | • | 2620-200 | SK20 | 2995-0030 | 673-0001 | SP2700-05 | SP1002-02 |
| CS | 2620-200 | 020 | 3/8" BSP | Foot | • | | SK20 | 2995-0030 | 673-0001 | SP2700-05 | SP1002-02 |
| DS / ES / GS | 9360 | 010 | 1/4" BSP | Foot | • | | SK223 | 1126 | 4528-0001 | AL22 | SP8019-01 |
| FK2 | 29300-2001 | 010 | 3/8" BSP | Flange | • | | SK404-0001 | 29308-0000 | 22405-0001 | SP2701-1006 | X3004-095G |
| FK3 | 29470-2031 | 020 | 3/8" BSP | Flange | • | | SK405-0001 | 29476-0000 | 18653-0001 | SP2701-1006 | X3004-095G |
| K 30 M | 9360 | 010 | 1/4" BSP | Foot | • | | SK223 | 1126 | 4528-0001 | AL22 | SP8019-01 |
| K 30 M | 11260-211 | 010 | 1/4" BSP | Flange | • | | SK266 | 1126 | 4528-0001 | SP2701-04 | SP1002-01 |
| K 30 | | | | | | Johnson Pump | | | 22405-0001 | | |
| K 34 | 29300-2401 | 010 | 3/8" BSP | Flange | • | | SK404-0001 | 29308-0000 | 22405-0001 | SP2701-1006 | X3004-095G |
| | 52010-2001 | 010 | 3/8" NPTF | Foot | • | 51510-2001 | SK404-0101 | 29308-0000 | 22405-0001 | SP2701-0501 | X3001-095F |
| | 52020-2031 | 020 | 1/2" BSP | Foot | | | SK405-0101 | 2995-0030 | 18653-0001 | SP2701-0501 | X3001-095F |
| L 30 | | | | | | Johnson Pump | | | 22405-0001 | | |
| P 30M / H | 6540-211 | 020 | 3/8" BSP | Foot | • | | SK205-01 | 2995-0030 | 673-0001 | B22 | SP8019-01 |
| Q 30M / H | | | | | | | | | 673-0001 | | |

11 Flexible Impeller Pumps

COOLING PUMP SPARES BY MAKE OF ENGINE



| JABSCO PUMP DETAILS | | | | | | | SERVICE KIT DETAILS | | | | |
|-----------------------|-------------------------|------|-----------|------------|----------|-----------------------|---------------------|------------------|------------|-------------|------------------|
| MODEL NUMBER | MODEL NUMBER * OEM ONLY | SIZE | PORT SIZE | MOUNT TYPE | OBSOLETE | ALTERNATE PUMP NUMBER | NUMBER | END COVER GASKET | IMPELLER | WATER SEAL | END COVER SCREWS |
| R 30M / H | 2620-211 | 020 | 3/8" BSP | Foot | • | 2620-200 | SK20 | 2995-0030 | 673-0001 | SP2700-05 | SP1002-02 |
| S 30M / H | 2620-211 | 020 | 3/8" BSP | Foot | • | 2620-200 | SK20 | 2995-0030 | 673-0001 | SP2700-05 | SP1002-02 |
| S 30M / H | 2620-200 | 020 | 3/8" BSP | Foot | • | | SK20 | 2995-0030 | 673-0001 | SP2700-05 | SP1002-02 |
| FLAGSHIP – USA | | | | | | | | | | | |
| GM 454 | 23800-0201 | 060 | Ø 32 Hose | Crank | | | SK331-0251 | 3298 | 22120-0001 | SP2701-21 | SP8019-01 |
| FNM – ITALY | | | | | | | | | | | |
| AM 20 / 45 / ATM 60 | 22770 | 020 | Ø 25 Hose | Crank | • | 29440-1001 | SK346 | 1985-01 | 673-0001 | SP2701-21 | SP1004-09 |
| AM 20 / 45 / ATM 60 | 29440-1001 | 020 | Ø 25 Hose | Crank | | | SK402-0001 | 1985-0000 | 18653-0001 | 29441-0000 | SP1004-09 |
| 1.3ATI | 52040-2001 | 040 | 3/4" BSP | Foot | | | SK384-0101 | 3298 | 1210-0001 | SP2701-1015 | X3001-095F |
| FORD – UK | | | | | | | | | | | |
| XLD 416 Escort | 22770-1101 | 020 | Ø 25 Hose | Crank | • | 29440-1101 | SK346 | 1985-01 | 673-0001 | SP2701-21 | SP1004-09 |
| XLD 416 Escort | 29440-1001 | 020 | Ø 25 Hose | Crank | | | SK402-0001 | 1985-0000 | 18653-0001 | 29441-0000 | SP1004-09 |
| FSD 425 | 52040-2001 | 040 | 3/4" BSP | Foot | | | SK384-0101 | 3298 | 1210-0001 | SP2701-1015 | X3001-095F |
| FSD 425A Transit | 3270-1951 | 040 | 3/4" BSP | Flange | • | | SK33 | 3298 | 1210-0001 | SP2701-21 | SP1002-02 |
| FSD 425B | 29500-1201 | 040 | Ø 28 Hose | Flange | | | SK384-0001 | 3298 | 1210-0001 | SP2700-1027 | SP1002-02 |
| BSD 333 / 444 / 666 | 23430-1201 | 080 | Ø 32 Hose | Flange | | | SK385-0001 | 890 | 17937-0001 | SP2700-1027 | SP1003-0111 |
| 2400 YORK | 21690 | 040 | Ø 20 Hose | Flange | • | | SK239 | 3298 | 1210-0001 | 22617-0010 | SP1002-02 |
| 2401E | 21690 | 040 | Ø 20 Hose | Flange | • | | SK239 | 3298 | 1210-0001 | 22617-0010 | SP1002-02 |
| 2700 Turbo | 21140-201 | 080 | 1" BSP | Flange | • | 21140-2401 | SK229 | 890 | 17937-0001 | 22617-0010 | SP1003-09 |
| 2704 ET | 21140-201 | 080 | 1" BSP | Flange | • | 21140-2401 | SK229 | 890 | 17937-0001 | 22617-0010 | SP1003-09 |
| 2704 ET | 21140-2401 | 080 | 1" BSP | Flange | | | SK229 | 890 | 17937-0001 | 22617-0010 | SP1003-09 |
| 2701 E | 10950-205 | 040 | 3/4" BSP | Flange | • | 10950-2401 | SK239 | 3298 | 1210-0001 | 22617-0010 | SP1002-02 |
| 2704 E | 10950-205 | 040 | 3/4" BSP | Flange | • | 10950-2401 | SK239 | 3298 | 1210-0001 | 22617-0010 | SP1002-02 |
| 2704 E | 10950-2401 | 040 | 3/4" BSP | Flange | | | SK239 | 3298 | 1210-0001 | 22617-0010 | SP1002-02 |
| 2704 ET / A | 10950-201 | 040 | 1/2" BSP | Flange | • | 10950-2401 | SK239 | 3298 | 1210-0001 | 22617-0010 | SP1002-02 |
| 2704 ET / A | 10950-2401 | 040 | 3/4" BSP | Flange | | | SK239 | 3298 | 1210-0001 | 22617-0010 | SP1002-02 |
| 2711 E | 10950-205 | 040 | 3/4" BSP | Flange | • | 10950-2401 | SK239 | 3298 | 1210-0001 | 22617-0010 | SP1002-02 |
| 2712 E | 10950-205 | 040 | 3/4" BSP | Flange | • | 10950-2401 | SK239 | 3298 | 1210-0001 | 22617-0010 | SP1002-02 |
| 2713 E | 10950-201 | 040 | 1/2" BSP | Flange | • | 10950-2401 | SK239 | 3298 | 1210-0001 | 22617-0010 | SP1002-02 |
| 2714 E | 10950-201 | 040 | 1/2" BSP | Flange | • | 10950-2401 | SK239 | 3298 | 1210-0001 | 22617-0010 | SP1002-02 |

| JABSCO PUMP DETAILS | | | | | | | SERVICE KIT DETAILS | | | | |
|-----------------------------------|-------------------------|------|----------------|------------|----------|-----------------------|---------------------|------------------|------------|-------------|------------------|
| MODEL NUMBER | MODEL NUMBER * OEM ONLY | SIZE | PORT SIZE | MOUNT TYPE | OBSOLETE | ALTERNATE PUMP NUMBER | NUMBER | END COVER GASKET | IMPELLER | WATER SEAL | END COVER SCREWS |
| 2714 E | 10950-2401 | 040 | 3/4" BSP | Flange | | | SK239 | 3298 | 1210-0001 | 22617-0010 | SP1002-02 |
| 2722 | 10950-2601 | 040 | 3/4" BSP | Flange | | | SK239 | 3298 | 1210-0001 | 22617-0010 | SP1002-02 |
| 2723 / 25 / 26T | 21140-2601 | 080 | 1" BSP | Flange | | | SK229 | 890 | 17937-0001 | 22617-0010 | SP1003-09 |
| GENESIS 4-cyl. | 29520-2001 | 040 | 3/4" BSP | Flange | | | SK239 | 3298 | 1210-0001 | 22617-0010 | SP1002-02 |
| GENESIS 6-cyl. | 29620-2001 | 080 | 1" BSP | Flange | | | SK229 | 890 | 17937-0001 | 22617-0010 | SP1003-09 |
| G & M POWER PLANT – UK | | | | | | | | | | | |
| 4 MDP | 29450-1201 | 020 | Ø 20 Hose | Flange | | | SK387-0001 | 2995-0030 | 673-0001 | SP2700-05 | SP1002-01 |
| BLMC 4 / 98 | 3270-241 | 040 | 3/4" BSP | Flange | • | | SK271 | 3298 | 1210-0001 | SP2701-21 | SP1002-02 |
| GARDNER – UK | | | | | | | | | | | |
| 4 LW (Oil Cooler) | 9710-200 | 080 | 1" BSP | Foot | | | SK229 | 890 | 17937-0001 | 22617-0010 | SP1003-09 |
| Tropical Service Only | | | | | | | | | | | |
| 4 LW | 6400-205 | 200 | 1-1/4" BSP | Foot | • | 52200-2051 | SK230 | 816 | 836-0001 | 21849 | SP1005-04 |
| 4 LW | 52200-2051 | 200 | 1-1/2" BSP | Foot | | | SK407-0011 | 816 | 17935-0001 | 21849 | X3001-176F |
| 6 LXB | 29600-1001 | 080 | Ø 32 Hose | Flange | | New Pipework | SK385-0101 | 890 | 17937-0001 | SP6080-0469 | SP1003-0111 |
| HAMWORTHY | | | | | | | | | | | |
| 2SF3, 3-4, 3-6 | 3370-200 | 040 | 3/4" BSP | Flange | • | 9970-200 | SK33 | 3298 | 1210-0001 | SP2701-21 | SP1002-02 |
| 2SF3, 3-4, 3-6 | 9970-200 | 040 | 3/4" BSP | Flange | | | SK229 | 3298 | 1210-0001 | 22617-0010 | SP1002-02 |
| 2TF5 | 4800-111 | 200 | 1-1/2" Flanged | Flange | • | 11790 | SK230 | 816 | 836-0001 | 21849 | SP1005-04 |
| 2TF5 Mk II and III | 11790 | 200 | 1-1/2" Flanged | Flange | • | | SK230 | 816 | 836-0001 | 21849 | SP1005-04 |
| 2TM6 Mk II and III | 11790-01 | 200 | 1-1/2" Flanged | Flange | • | | SK230 | 816 | 836-0001 | 21849 | SP1005-04 |
| 2MF6 | 10590-61 | 270 | 2" Flanged | Flange | • | 10590-62 | SK254 | 816 | 21676-0001 | 21849 | SP1005-04 |
| 2MF62 | 10590-61 | 270 | 2" Flanged | Flange | • | 10590-62 | SK254 | 816 | 21676-0001 | 21849 | SP1005-04 |
| 2MF64 | 10590-61 | 270 | 2" Flanged | Flange | • | 10590-62 | SK254 | 816 | 21676-0001 | 21849 | SP1005-04 |
| 2MF64 | 10590-62 | 270 | 2" Flanged | Flange | | | SK254 | 816 | 21676-0001 | 21849 | SP1005-04 |
| 2SF4, 42 | 9700-01 | 080 | 1" Flanged | Flange | | | SK238 | 890 | 17937-0001 | SP6080-06 | SP1003-01 |
| HARDIN MARINE – USA | | | | | | | | | | | |
| GM V8 | 23800-0251 | 060 | Ø 32 Hose | Crank | • | 23800-0201 | SK331-0251 | 3298 | 22120-0001 | SP2701-21 | SP8019-01 |
| GM V8 | 23800-0201 | 060 | Ø 32 Hose | Crank | | | SK331-0251 | 3298 | 22120-0001 | SP2701-21 | SP8019-01 |

11 Flexible Impeller Pumps

COOLING PUMP SPARES BY MAKE OF ENGINE



| JABSCO PUMP DETAILS | | | | | | | SERVICE KIT DETAILS | | | | |
|------------------------------------|-------------------------|------|----------------|------------|----------|-----------------------|---------------------|------------------|------------|-------------|------------------|
| MODEL NUMBER | MODEL NUMBER * OEM ONLY | SIZE | PORT SIZE | MOUNT TYPE | OBSOLETE | ALTERNATE PUMP NUMBER | NUMBER | END COVER GASKET | IMPELLER | WATER SEAL | END COVER SCREWS |
| HAWKER SIDDELEY MARINE – UK | | | | | | | | | | | |
| AB 1W | 9040-0511 | 005 | 1/2" Hose | Flange | | now -1021 | SK92-11 | 7828-01 | 14609-0001 | SP3000-10 | SP1002-09 |
| AC 1W | 6640-205 | 010 | 3/8" BSP | Foot | • | 52010-2001 | SK23 | 1189 | 4528-0001 | SP2701-11 | SP1002-01 |
| AC 2W | 6640-205 | 010 | 3/8" BSP | Foot | • | 52010-2001 | SK23 | 1189 | 4528-0001 | SP2701-11 | SP1002-01 |
| AC 2W | 52010-2001 | 010 | 3/8" NPTF | Foot | • | 51510-2001 | SK404-0101 | 29308-0000 | 22405-0001 | SP2701-0501 | X3001-095F |
| PJ W | 10420 | 020 | Ø 16 Hose | Flange | • | 29490-2001C | SK211 | 10817 | 673-0001 | SP2701-04 | SP1002-09 |
| PJ 3 | 10420 | 020 | Ø 16 Hose | Flange | • | 29490-2001C | SK211 | 10817 | 673-0001 | SP2701-04 | SP1002-09 |
| PJ 4 | 10420 | 020 | Ø 16 Hose | Flange | • | 29490-2001C | SK211 | 10817 | 673-0001 | SP2701-04 | SP1002-09 |
| PJ 4 | 29490-2001C | 020 | 3/8" BSP | Flange | • | | SK405-0001 | 29476-0000 | 18653-0001 | SP2701-1006 | X3004-095G |
| PM 1W / 2W | 5870 | 020 | 1/2" BSP | Flange | • | | SK243 | 5878 | 1210-0001 | SP2701-09 | SP1002-09 |
| PJ 1W / 2W | 5870 | 020 | 1/2" BSP | Flange | • | | SK243 | 5878 | 1210-0001 | SP2701-09 | SP1002-09 |
| AV / HP-Series | 5870 | 020 | 1/2" BSP | Flange | • | | SK243 | 5878 | 1210-0001 | SP2701-09 | SP1002-09 |
| FR 1 / 2 / 3 MGR | 3380-200 | 040 | 3/4" BSP | Flange | • | 9970-200 | SK33 | 3298 | 1210-0001 | SP2701-21 | SP1002-02 |
| FR 4 / 6 MGR | 3370-200 | 040 | 3/4" BSP | Flange | • | 9970-200 | SK33 | 3298 | 1210-0001 | SP2701-21 | SP1002-02 |
| FR 4 / 6 MGR | 9970-200 | 040 | 3/4" BSP | Flange | | | SK229 | 3298 | 1210-0001 | 22617-0010 | SP1002-02 |
| HA / HR / HRW 4 / 6 | 3370-251 | 040 | 3/4" BSP | Flange | • | 9970-261 | SK33 | 3298 | 1210-0001 | SP2701-21 | SP1002-02 |
| (Direct Cooling) | 9970-261 | 040 | 3/4" BSP | Flange | | | SK239 | 3298 | 1210-0001 | 22617-0010 | SP1002-02 |
| HA / HW-Series | 9970-271 | 040 | 3/4" BSP | Flange | • | 9970-200 | SK239 | 3298 | 1210-0001 | 22617-0010 | SP1002-02 |
| (Manifold) | 3380-221 | 040 | 1/2" BSP | Flange | • | 9970-200 | SK33 | 3298 | 1210-0001 | SP2701-21 | SP1002-02 |
| HA / HR / HRW 2 | 3370-200 | 040 | 3/4" BSP | Flange | • | 9970-200 | SK33 | 3298 | 1210-0001 | SP2701-21 | SP1002-02 |
| (2- and 3-cylinder Heat Exchanger) | 9970-200 | 040 | 3/4" BSP | Flange | | | SK229 | 3298 | 1210-0001 | 22617-0010 | SP1002-02 |
| JA4 / JW4 / JA6 / JW6 | 10880-07 | 200 | 1-1/2" Flanged | Flange | • | | SK230 | 816 | 836-0001 | 21849 | SP1005-04 |
| JP and JK-Series | 6420-205 | 080 | 1" BSP | Foot | • | 52080-2051 | SK236 | 890 | 17937-0001 | SP2701-21 | SP1003-09 |
| | 52080-2051 | 080 | 1" BSP | Foot | | | SK406-0001 | 890 | 17937-0001 | SP2700-48 | X3001-147F |
| SL and SR-Series | AL 1/4"-200 | 010 | 1/4" BSP | Foot | | | SK1 | 1126 | 4528-0001 | AL22 | SP1002-01 |
| SL4 | 6640-200 | 010 | 1/4" BSP | Foot | • | 52010-2001 | SK23 | 1189 | 4528-0001 | SP2701-11 | SP1002-01 |
| (Manifold) | 52010-2001 | 010 | 3/8" NPTF | Foot | • | 51510-2001 | SK404-0101 | 29308-0000 | 22405-0001 | SP2701-0501 | X3001-095F |
| TS3 | 6420-2051 | 080 | 1" BSP | Foot | • | 52080-2051 | SK385-0201 | 2432 | 17937-0001 | SP2700-1027 | SP1003-09 |
| TS3 | 52080-2051 | 080 | 1" BSP | Foot | | | SK406-0001 | 890 | 17937-0001 | SP2700-48 | X3001-147F |

| JABSCO PUMP DETAILS | | | | | | | SERVICE KIT DETAILS | | | | |
|---------------------------------|-------------------------|------|----------------|------------|----------|-----------------------|---------------------|------------------|------------|-------------|------------------|
| MODEL NUMBER | MODEL NUMBER * OEM ONLY | SIZE | PORT SIZE | MOUNT TYPE | OBSOLETE | ALTERNATE PUMP NUMBER | NUMBER | END COVER GASKET | IMPELLER | WATER SEAL | END COVER SCREWS |
| STW2 MGR | 11620-211 | 010 | 1/4" BSP | Flange | • | | SK23 | 1189 | 4528-0001 | SP2701-11 | SP1002-01 |
| STW3 MGR | 6520-2003 | 080 | 1" BSP | Foot | • | 51080-2003 | SK385-0403 | 890 | 17937-0003 | SP2700-1027 | SP1003-09 |
| STW3 MGR | 51080-2003 | 080 | 1" BSP | Foot | • | | SK406-0003 | 890 | 17937-0003 | SP2700-1027 | X3001-147F |
| HRW4 | 9970-271 | 040 | 3/4" BSP | Flange | • | 9970-200 | SK239 | 3298 | 1210-0001 | 22617-0010 | SP1002-02 |
| HRW4 | 9970-200 | 040 | 3/4" BSP | Flange | | | SK229 | 3298 | 1210-0001 | 22617-0010 | SP1002-02 |
| HSM D3, 152M | 29500-1101 | 040 | Ø 28 Hose | Flange | • | | SK384-0001 | 3298 | 1210-0001 | SP2700-1027 | SP1002-02 |
| Piranha 4-cyl. | 6490-132 | 040 | 1/2" BSP | Foot | • | | SK225-01 | 6496 | 1210-0001 | SP2701-21 | SP1003-09 |
| ALPHA Series | | | | | | | | | | | |
| LPW2 | 29480-2151 | 020 | 3/8" BSP | Flange | • | | SK405-0001 | 29476-0000 | 18653-0001 | SP2701-1006 | X3004-095G |
| LPW3 | 29480-2131 | 020 | 3/8" BSP | Flange | • | | SK405-0001 | 29476-0000 | 18653-0001 | SP2701-1006 | X3004-095G |
| LPW4 | 29500-1451 | 040 | Ø 28 Hose | Flange | • | | SK384-0001 | 3298 | 1210-0001 | SP2700-1027 | SP1002-02 |
| CRK3 | 23430-1201 | 080 | Ø 32 Hose | Flange | | | SK385-0001 | 890 | 17937-0001 | SP2700-1027 | SP1003-0111 |
| Ford Dover | | | | | | | | | | | |
| CS4 | 21140-2601 | 080 | 1" BSP | Flange | | | SK229 | 890 | 17937-0001 | 22617-0010 | SP1003-09 |
| CS6 | 21140-2601 | 080 | 1" BSP | Flange | | | SK229 | 890 | 17937-0001 | 22617-0010 | SP1003-09 |
| CST6 | 21140-2601 | 080 | 1" BSP | Flange | | | SK229 | 890 | 17937-0001 | 22617-0010 | SP1003-09 |
| CST16 | 21140-2601 | 080 | 1" BSP | Flange | | | SK229 | 890 | 17937-0001 | 22617-0010 | SP1003-09 |
| HFL – UK | | | | | | | | | | | |
| 1500 VW | 22620 | 020 | Ø 25 Hose | Crank | • | 29440-1101 | SK346 | 1985-01 | 673-0001 | SP6080-08B | SP1004-09 |
| 1501 VW | 29440-1101 | 020 | Ø 25 Hose | Crank | | | SK402-0001 | 1985-0000 | 18653-0001 | 29441-0000 | SP1004-09 |
| PETTER | 52010-2001 | 010 | 3/8" NPTF | Foot | • | 51510-2001 | SK404-0101 | 29308-0000 | 22405-0001 | SP2701-0501 | X3001-095F |
| INDMAR – USA | | | | | | | | | | | |
| Ford / GM 8-cyl. | 23800-0251 | 060 | Ø 32 Hose | Crank | • | 23800-0201 | SK331-0251 | 3298 | 22120-0001 | SP2701-21 | SP8019-01 |
| | 23800-0201 | 060 | Ø 32 Hose | Crank | | | SK331-0251 | 3298 | 22120-0001 | SP2701-21 | SP8019-01 |
| ISOTTA FRASCHINI – ITALY | | | | | | | | | | | |
| D 30.55-6L | 10950-201 | 040 | 1/2" BSP | Flange | • | 10950-2401 | SK239 | 3298 | 1210-0001 | 22617-0010 | SP1002-02 |
| D 30.55-6L | 10950-2401 | 040 | 3/4" BSP | Flange | | | SK239 | 3298 | 1210-0001 | 22617-0010 | SP1002-02 |
| ID 32 | 10630-07 | 200 | 1-1/2" Flanged | Foot | • | 52220-0011 | SK230 | 816 | 836-0001 | 21849 | SP1005-04 |
| ID 32 | 52220-0011 | 200 | 1-1/2" Flanged | Foot | | | SK407-0011 | 816 | 17935-0001 | | X3001-176F |

11 Flexible Impeller Pumps

COOLING PUMP SPARES BY MAKE OF ENGINE



| JABSCO PUMP DETAILS | | | | | | | SERVICE KIT DETAILS | | | | |
|---------------------|-------------------------|------|------------|------------|----------|-----------------------|---------------------|------------------|------------|------------|------------------|
| MODEL NUMBER | MODEL NUMBER * OEM ONLY | SIZE | PORT SIZE | MOUNT TYPE | OBSOLETE | ALTERNATE PUMP NUMBER | NUMBER | END COVER GASKET | IMPELLER | WATER SEAL | END COVER SCREWS |
| ID 36 / 38 | 11150-0011 | 200 | 2" Flanged | Foot | • | | SK254 | 816 | 21676-0001 | 21849 | SP1005-04 |
| H 130 | 11150-0011 | 200 | 2" Flanged | Foot | • | | SK254 | 816 | 21676-0001 | 21849 | SP1005-04 |
| L 1306 T2 | 10590-0201 | 270 | 2" Flanged | Flange | • | | SK254 | 816 | 21676-0001 | 21849 | SP1005-04 |
| V 1308 T2 | 10490-07 | 270 | 2" Flanged | Foot | • | 50270-0911 | SK254 | 816 | 21676-0001 | 21849 | SP1005-04 |
| V 1308 T2 | 50270-0911 | 270 | 2" Flanged | Foot | • | | SK408-0011 | 816 | 17936-0001 | 21849 | SP1095-0640 |

KELVIN – UK

DB Series

| | | | | | | | | | | | |
|--|------------|-----|----------------|--------|---|--------------|------------|-----|------------|-------------|------------|
| | 6400-207 | 200 | 1-1/4" BSP | Foot | • | 52200-2001 | SK230 | 816 | 836-0001 | SP6080-0374 | SP1005-04 |
| | 52200-2001 | 200 | 1-1/2" BSP | Foot | • | 52200-2011 | SK407-0011 | 816 | 17935-0001 | SP6080-0374 | X3001-176F |
| | 52200-2011 | 200 | 1-1/2" BSP | Foot | | | SK407-0011 | 816 | 17935-0001 | SP6080-0374 | X3001-176F |
| | 4800-51 | 200 | 1-1/2" Flanged | Flange | • | | SK230 | 816 | 836-0001 | 21849 | SP1005-04 |
| | 6590-237 | 200 | 1-1/4" BSP | Foot | • | 51200-2003 | SK230-37 | 816 | 836-0003 | SP6080-0374 | SP1005-04 |
| | 51200-2003 | 200 | 1-1/2" BSP | Foot | • | Bilge Option | SK407-0003 | 816 | 836-0003 | SP6080-0374 | X3001-176F |
| | 6520-2003 | 080 | 1" BSP | Foot | • | 51080-2003 | SK385-0403 | 890 | 17937-0003 | SP2700-1027 | SP1003-09 |
| | 51080-2003 | 080 | 1" BSP | Foot | • | | SK406-0003 | 890 | 17937-0003 | SP2700-1027 | X3001-147F |

KTT

| | | | | | | | | | | | |
|-----------------|-----------|-----|----------|--------|---|--|-------|------|-----------|-----------|-----------|
| KUBOTA KTT 2000 | 3270-2401 | 040 | 3/4" BSP | Flange | • | | SK271 | 3298 | 1210-0001 | SP2701-21 | SP1002-02 |
| KUBOTA KTT 3000 | 3270-2401 | 040 | 3/4" BSP | Flange | • | | SK271 | 3298 | 1210-0001 | SP2701-21 | SP1002-02 |

KUBOTA

| | | | | | | | | | | | |
|----------|------------|-----|-----------|--------|---|------------|------------|-----------|------------|-------------|-----------|
| BZ482 | 29460-1401 | 020 | Ø 20 Hose | Flange | • | 29460-1631 | SK401-0001 | 2995-0030 | 18653-0001 | SP2701-1006 | SP1002-01 |
| BD722 | 29460-1401 | 020 | Ø 20 Hose | Flange | • | 29460-1631 | SK401-0001 | 2995-0030 | 18653-0001 | SP2701-1006 | SP1002-01 |
| BD1005 | 29460-1401 | 020 | Ø 20 Hose | Flange | • | 29460-1631 | SK401-0001 | 2995-0030 | 18653-0001 | SP2701-1006 | SP1002-01 |
| BV1305 | 29460-1401 | 020 | Ø 20 Hose | Flange | • | 29460-1631 | SK401-0001 | 2995-0030 | 18653-0001 | SP2701-1006 | SP1002-01 |
| BV1505 | 29460-1401 | 020 | Ø 20 Hose | Flange | • | 29460-1631 | SK401-0001 | 2995-0030 | 18653-0001 | SP2701-1006 | SP1002-01 |
| BV1903 | 29460-1401 | 020 | Ø 20 Hose | Flange | • | 29460-1631 | SK401-0001 | 2995-0030 | 18653-0001 | SP2701-1006 | SP1002-01 |
| BV2203 | 29460-1401 | 020 | Ø 20 Hose | Flange | • | 29460-1631 | SK401-0001 | 2995-0030 | 18653-0001 | SP2701-1006 | SP1002-01 |
| BF2803 | 29460-1401 | 020 | Ø 20 Hose | Flange | • | 29460-1631 | SK401-0001 | 2995-0030 | 18653-0001 | SP2701-1006 | SP1002-01 |
| KTT 2000 | 3270-2401 | 040 | 3/4" BSP | Flange | • | | SK271 | 3298 | 1210-0001 | SP2701-21 | SP1002-02 |
| KTT 3000 | 3270-2401 | 040 | 3/4" BSP | Flange | • | | SK271 | 3298 | 1210-0001 | SP2701-21 | SP1002-02 |

| JABSCO PUMP DETAILS | | | | | | | SERVICE KIT DETAILS | | | | |
|----------------------------|-------------------------|------|-----------|------------|----------|-----------------------|---------------------|------------------|------------|-------------|------------------|
| MODEL NUMBER | MODEL NUMBER * OEM ONLY | SIZE | PORT SIZE | MOUNT TYPE | OBSOLETE | ALTERNATE PUMP NUMBER | NUMBER | END COVER GASKET | IMPELLER | WATER SEAL | END COVER SCREWS |
| LANCING MARINE – UK | | | | | | | | | | | |
| BMC 1.5+1.8 | 22960-2001 | 010 | Ø 19 Hose | Foot | • | | SK355 | 21646 | 4528-0001 | SP2701-14 | SP1002-09 |
| BMC 2.2+2.5 | 3270-241 | 040 | 3/4" BSP | Flange | • | | SK271 | 3298 | 1210-0001 | SP2701-21 | SP1002-02 |
| BMC 3.4+3.8 (4/98) 5.1 | 29500-1001 | 040 | Ø 28 Hose | Flange | | | SK384-0001 | 3298 | 1210-0001 | SP2700-1027 | SP1002-02 |
| BMC 5.7 + 6/98 | 22770 | 020 | Ø 25 Hose | Crank | • | 29440-1001 | SK346 | 1985-01 | 673-0001 | SP2701-21 | SP1004-09 |
| BMC 5.7 + 6/98 | 29440-1001 | 020 | Ø 25 Hose | Crank | | | SK402-0001 | 1985-0000 | 18653-0001 | 29441-0000 | SP1004-09 |
| Chev V8 | 22740-0151 | 060 | Ø 32 Hose | Crank | • | | SK331-05 | 3298 | 22120-0001 | SP2701-21 | SP8019-01 |
| Ford | | | | | | | | | | | |
| 2700 / 2710 / 2720 | 10950-201 | 040 | 1/2" BSP | Flange | • | 10950-2401 | SK239 | 3298 | 1210-0001 | 22626-6000 | SP1002-02 |
| 2700 / 2710 / 2720 | 10950-2401 | 040 | 3/4" BSP | Flange | | | SK239 | 3298 | 1210-0001 | 22626-6000 | SP1002-02 |
| Turbo 4 PC / 6 / Int. | 21140-201 | 080 | 1" BSP | Flange | • | 21140-2401 | SK229 | 890 | 17937-0001 | 22626-6000 | SP1003-09 |
| Turbo 4 PC / 6 / Int. | 21140-2401 | 080 | 1" BSP | Flange | | | SK229 | 890 | 17937-0001 | 22626-6000 | SP1003-09 |
| 1.1 / 1.6 / 2.0 / OHC / V4 | 22960-2001 | 010 | Ø 19 Hose | Foot | • | | SK355 | 21646 | 4528-0001 | SP2701-14 | SP1002-09 |
| V6 2.3 / 2.8 / 2.5 / 3.0 | 22770 | 020 | Ø 25 Hose | Crank | • | 29440-1001 | SK346 | 1985-01 | 673-0001 | SP2701-21 | SP1004-09 |
| V6 2.3 / 2.8 / 2.5 / 3.0 | 29440-1001 | 020 | Ø 25 Hose | Crank | | | SK402-0001 | 1985-0000 | 18653-0001 | 29441-0000 | SP1004-09 |
| 590E / 592E | 21820-2001 | 040 | 3/4" BSP | Foot | • | 52040-2001 | SK33 | 3298 | 1210-0001 | SP2701-21 | SP1002-02 |
| (4-cylinder) | 52040-2001 | 040 | 3/4" BSP | Foot | | | SK384-0101 | 3298 | 1210-0001 | SP2701-1015 | X3001-095F |
| Ford Genesis | | | | | | | | | | | |
| 4-cyl. | 29520-2001 | 040 | 3/4" BSP | Flange | | | SK239 | 3298 | 1210-0001 | 22626-6000 | SP1002-02 |
| 6-cyl. | 29620-2001 | 080 | 1" BSP | Flange | | | SK229 | 890 | 17937-0001 | 22626-6000 | SP1003-09 |
| Gardner | | | | | | | | | | | |
| 6LX + 6LXB + 8LXB | 6420-2001 | 080 | 1" BSP | Foot | • | 52080-2001 | SK385-0201 | 890 | 17937-0001 | SP2700-1027 | SP1003-09 |
| 6LX + 6LXB + 8LXB | 52080-2001 | 080 | 1" BSP | Foot | | | SK406-0001 | 890 | 17937-0001 | SP2700-48 | X3001-147F |
| GM / Bedford | | | | | | | | | | | |
| 220 + 330 | 22770 | 020 | Ø 25 Hose | Crank | • | 29440-1001 | SK346 | 1985-01 | 673-0001 | SP2701-21 | SP1004-09 |
| 220 + 330 | 29440-1001 | 020 | Ø 25 Hose | Crank | | | SK402-0001 | 1985-0000 | 18653-0001 | 29441-0000 | SP1004-09 |
| 381 + 466 + 500 | 22740-0151 | 060 | Ø 32 Hose | Crank | • | | SK331-05 | 3298 | 22120-0001 | SP2701-21 | SP8019-01 |
| Jaguar | | | | | | | | | | | |
| 2.4 + 4.2 | 29500-1001 | 040 | Ø 28 Hose | Flange | | | SK384-0001 | 3298 | 1210-0001 | SP2700-1027 | SP1002-02 |

11 Flexible Impeller Pumps

COOLING PUMP SPARES BY MAKE OF ENGINE



| JABSCO PUMP DETAILS | | | | | | | SERVICE KIT DETAILS | | | | |
|------------------------------|-------------------------|------|----------------|------------|----------|-----------------------|---------------------|------------------|------------|-------------|------------------|
| MODEL NUMBER | MODEL NUMBER * OEM ONLY | SIZE | PORT SIZE | MOUNT TYPE | OBSOLETE | ALTERNATE PUMP NUMBER | NUMBER | END COVER GASKET | IMPELLER | WATER SEAL | END COVER SCREWS |
| Leyland | | | | | | | | | | | |
| 400 + 401 + 402 | 23080-1151 | 060 | Ø 32 Hose | Flange | • | | SK363-0051 | 3298 | 22120-0001 | 22626-6000 | SP1002-01 |
| Mercedes | | | | | | | | | | | |
| 180 + 190 + 200 + 220 | 22960-2001 | 010 | Ø 19 Hose | Foot | • | | SK355 | 21646 | 4528-0001 | SP2701-14 | SP1002-09 |
| OM314 + 321 + 352 | 22770 | 020 | Ø 25 Hose | Crank | • | 29440-1001 | SK346 | 1985-01 | 673-0001 | SP2701-21 | SP1004-09 |
| OM314 + 321 + 352 | 29440-1001 | 020 | Ø 25 Hose | Crank | | | SK402-0001 | 1985-0000 | 18653-0001 | 29441-0000 | SP1004-09 |
| Perkins | | | | | | | | | | | |
| 3.152 | 22960-2001 | 010 | Ø 19 Hose | Foot | • | | SK355 | 21646 | 4528-0001 | SP2701-14 | SP1002-09 |
| 4.203 | 29500-1001 | 040 | Ø 28 Hose | Flange | | | SK384-0001 | 3298 | 1210-0001 | SP2700-1027 | SP1002-02 |
| 4.236 | 10970 | 040 | 3/4" BSP | Flange | | | SK268-01 | 3298 | 1210-0001 | 22626-6000 | SP1002-02 |
| 4.248 | 22770 | 020 | Ø 25 Hose | Crank | • | 29440-1001 | SK346 | 1985-01 | 673-0001 | SP2701-21 | SP1004-09 |
| 4.248 | 29440-1001 | 020 | Ø 25 Hose | Crank | | | SK402-0001 | 1985-0000 | 18653-0001 | 29441-0000 | SP1004-09 |
| 6.354 | 21820-2001 | 040 | 3/4" BSP | Foot | • | 52040-2001 | SK33 | 3298 | 1210-0001 | SP2701-21 | SP1002-02 |
| 6.354 | 52040-2001 | 040 | 3/4" BSP | Foot | | | SK384-0101 | 3298 | 1210-0001 | SP2701-1015 | X3001-095F |
| T6 354 | 6420-2001 | 080 | 1" BSP | Foot | • | 52080-2001 | SK385-0201 | 890 | 17937-0001 | SP2700-1027 | SP1003-09 |
| T6 354 | 52080-2001 | 080 | 1" BSP | Foot | | | SK406-0001 | 890 | 17937-0001 | SP2700-48 | X3001-147F |
| 510 V8 | 11120-200 | 080 | 1" BSP | Flange | • | | SK229 | 890 | 17937-0001 | 22626-6000 | SP1003-09 |
| 4.99 + 4.107 + 4.108 | 22960-2001 | 010 | Ø 19 Hose | Foot | • | | SK355 | 21646 | 4528-0001 | SP2701-14 | SP1002-09 |
| Peugeot | | | | | | | | | | | |
| XD2 1.9 & 2.5 | 22770 | 020 | Ø 25 Hose | Crank | • | 29440-1001 | SK346 | 1985-01 | 673-0001 | SP2701-21 | SP1004-09 |
| XD2 1.9 & 2.5 | 29440-1001 | 020 | Ø 25 Hose | Crank | | | SK402-0001 | 1985-0000 | 18653-0001 | 29441-0000 | SP1004-09 |
| Volvo | | | | | | | | | | | |
| TD70 + TD70E | 11120-200 | 080 | 1" BSP | Flange | • | | SK229 | 890 | 17937-0001 | 22626-6000 | SP1003-09 |
| VW Golf | | | | | | | | | | | |
| 1500 + 1600 | 22960-2001 | 010 | Ø 19 Hose | Foot | • | | SK355 | 21646 | 4528-0001 | SP2701-14 | SP1002-09 |
| LEHMAN POWER LTD – UK | | | | | | | | | | | |
| 4D220 | 6420-0101 | 080 | 1" NPT | Foot | • | 52220-0011 | SK236 | 890 | 17937-0001 | SP2701-21 | SP1003-09 |
| 4D220 | 52220-0011 | 200 | 1-1/2" Flanged | Foot | | | SK407-0011 | 816 | 17935-0001 | SP6080-0374 | X3001-176F |
| 6D380 | 5850-0001 | 040 | 3/4" NPT | Flange | | | SK33 | 3298 | 1210-0001 | SP2701-21 | SP1002-02 |
| Mercraft 24 / 57 | 21690-200 | 040 | 3/4" BSP | Flange | • | | SK239 | 3298 | 1210-0001 | 22626-6000 | SP1002-02 |
| Mercraft 24 / 87 | 21690-200 | 040 | 3/4" BSP | Flange | • | | SK239 | 3298 | 1210-0001 | 22626-6000 | SP1002-02 |

| JABSCO PUMP DETAILS | | | | | | | SERVICE KIT DETAILS | | | | |
|---------------------------------|-------------------------|------|------------|------------|----------|-----------------------|---------------------|------------------|------------|-------------|------------------|
| MODEL NUMBER | MODEL NUMBER * OEM ONLY | SIZE | PORT SIZE | MOUNT TYPE | OBSOLETE | ALTERNATE PUMP NUMBER | NUMBER | END COVER GASKET | IMPELLER | WATER SEAL | END COVER SCREWS |
| Mercraft 80 | 10950-204 | 040 | 3/4" BSP | Flange | • | 10950-2401 | SK239 | 3298 | 1210-0001 | 22626-6000 | SP1002-02 |
| Mercraft 120 | 10950-204 | 040 | 3/4" BSP | Flange | • | 10950-2401 | SK239 | 3298 | 1210-0001 | 22626-6000 | SP1002-02 |
| Mercraft 120 | 10950-2401 | 040 | 3/4" BSP | Flange | | | SK239 | 3298 | 1210-0001 | 22626-6000 | SP1002-02 |
| Mercraft 150 Turbo | 3370-200 | 040 | 3/4" BSP | Flange | • | 9970-200 | SK33 | 3298 | 1210-0001 | SP2701-21 | SP1002-02 |
| Mercraft 150 Turbo | 9970-200 | 040 | 3/4" BSP | Flange | | | SK229 | 3298 | 1210-0001 | 22626-6000 | SP1002-02 |
| Mercraft 180 Turbo | 21140-200 | 080 | 1" BSP | Flange | • | 21140-2401 | SK229 | 890 | 17937-0001 | 22626-6000 | SP1003-09 |
| Mercraft 180 Turbo | 21140-2401 | 080 | 1" BSP | Flange | | | SK229 | 890 | 17937-0001 | 22626-6000 | SP1003-09 |
| Mercraft 210 Turbo | 21580-200 | 080 | 1" BSP | Flange | • | | SK229 | 890 | 17937-0001 | 22626-6000 | SP1003-09 |
| Mercraft 250 Turbo | 21580-200 | 080 | 1" BSP | Flange | • | | SK229 | 890 | 17937-0001 | 22626-6000 | SP1003-09 |
| Mercraft 150 Turbo Inc. | 10950-204 | 040 | 3/4" BSP | Flange | • | 10950-2401 | SK239 | 3298 | 1210-0001 | 22626-6000 | SP1002-02 |
| Mercraft 150 Turbo Inc. | 21140-2401 | 080 | 1" BSP | Flange | | | SK229 | 890 | 17937-0001 | 22626-6000 | SP1003-09 |
| Mercraft 180 Turbo Inc. | 21140-204 | 080 | 1" BSP | Flange | • | 21140-2401 | SK229 | 890 | 17937-0001 | 22626-6000 | SP1003-09 |
| Mercraft 180 Turbo Inc. | 21140-2401 | 080 | 1" BSP | Flange | | | SK229 | 890 | 17937-0001 | 22626-6000 | SP1003-09 |
| Ford Dover | 10950-2601 | 040 | 3/4" BSP | Flange | | | SK239 | 3298 | 1210-0001 | 22626-6000 | SP1002-02 |
| Ford Dover | 21140-2601 | 080 | 1" BSP | Flange | | | SK229 | 890 | 17937-0001 | 22626-6000 | SP1003-09 |
| Super 355 | 29700-1201 | 120 | Ø 45 Hose | Flange | | | SK386-0001 | 890 | 17018-0001 | SP6080-0469 | SP1003-0111 |
| LEYLAND THORNYCROFT – UK | | | | | | | | | | | |
| RF LD-220 | 4900-201 | 040 | 1/2" BSP | Foot | • | | SK234 | 4908 | 4568-0001 | 3791 | SP1003-09 |
| RF 6-330 | JD 3/4"-201 | 040 | 3/4" BSP | Foot | • | JD 3/4"-200 | SK220 | 706-01 | 4598-0001 | 3791 | SP1003-02 |
| RF 6-330 | JD 3/4"-200 | 040 | 3/4" BSP | Foot | | | SK220 | 706-01 | 4598-0001 | C20 | SP1003-02 |
| 90 / 90E / 90 / 2 / 108 / 2 | 4900-200 | 040 | 1/2" BSP | Foot | • | | SK234 | 4908 | 4568-0001 | 3791 | SP1003-09 |
| 90 / 90E / 90 / 2 / 108 / 2 | 52040-2401 | 040 | 3/4" BSP | Foot | | | SK384-0101 | 3298 | 1210-0001 | SP2701-1015 | X3001-095F |
| 138 / 152 / 154 / 160 | 3270-271 | 040 | 3/4" BSP | Flange | • | | SK271 | 3298 | 1210-0001 | SP2701-21 | SP1002-02 |
| 230 | 9700-151 | 080 | 1" Flanged | Flange | • | | SK238-01 | 3101 | 17937-0001 | SP6080-06 | SP1003-01 |
| 238 / T 238 | 23430-1301 | 080 | Ø 32 Hose | Flange | | | SK385-0001 | 890 | 17937-0001 | SP2700-1027 | SP1003-0111 |
| 240 / 250 / 251 | 10950-204 | 040 | 3/4" BSP | Flange | • | 10950-2401 | SK239 | 3298 | 1210-0001 | 22626-6000 | SP1002-02 |
| 240 / 250 / 251 | 10950-2401 | 040 | 3/4" BSP | Flange | | | SK239 | 3298 | 1210-0001 | 22626-6000 | SP1002-02 |

11 Flexible Impeller Pumps

COOLING PUMP SPARES BY MAKE OF ENGINE



| JABSCO PUMP DETAILS | | | | | | | SERVICE KIT DETAILS | | | | |
|--------------------------|-------------------------|------|----------------|------------|----------|-----------------------|---------------------|------------------|------------|-------------|------------------|
| MODEL NUMBER | MODEL NUMBER * OEM ONLY | SIZE | PORT SIZE | MOUNT TYPE | OBSOLETE | ALTERNATE PUMP NUMBER | NUMBER | END COVER GASKET | IMPELLER | WATER SEAL | END COVER SCREWS |
| 331 | 10950-200 | 040 | 3/4" BSP | Flange | • | 10950-2401 | SK239 | 3298 | 1210-0001 | 22626-6000 | SP1002-02 |
| 331 | 10950-2401 | 040 | 3/4" BSP | Flange | | | SK239 | 3298 | 1210-0001 | 22626-6000 | SP1002-02 |
| 345 | 9700-171 | 080 | 1" Flanged | Flange | • | | SK238 | 890 | 17937-0001 | SP6080-06 | SP1003-01 |
| 358 / T358 / TA358 | 23430-1301 | 080 | Ø 32 Hose | Flange | | | SK385-0001 | 890 | 17937-0001 | SP2700-1027 | SP1003-0111 |
| 360 | 10950-200 | 040 | 3/4" BSP | Flange | • | 10950-2401 | SK239 | 3298 | 1210-0001 | 22626-6000 | SP1002-02 |
| 360 | 10950-2401 | 040 | 3/4" BSP | Flange | | | SK239 | 3298 | 1210-0001 | 22626-6000 | SP1002-02 |
| 360.1 / T360.1 / 380 / 1 | 21140-204 | 080 | 1" BSP | Flange | • | 21140-2401 | SK229 | 890 | 17937-0001 | 22626-6000 | SP1003-09 |
| 360.1 / T360.1 / 380 / 1 | 10950-2401 | 040 | 3/4" BSP | Flange | | | SK239 | 3298 | 1210-0001 | 22626-6000 | SP1002-02 |
| 400 / T400 / 500 | 9700-01 | 080 | 1" Flanged | Flange | | | SK238 | 890 | 17937-0001 | SP6080-06 | SP1003-01 |
| T500 | 4800-51 | 200 | 1-1/2" Flanged | Flange | • | | SK230 | 816 | 836-0001 | 21849 | SP1005-04 |
| 590 / 690 / 691 / 760 | 6400-205 | 200 | 1-1/4" BSP | Foot | • | 52200-2051 | SK230 | 816 | 836-0001 | SP6080-0374 | SP1005-04 |
| 590 / 690 / 691 / 760 | 52200-2051 | 200 | 1-1/2" BSP | Foot | | | SK407-0011 | 816 | 17935-0001 | SP6080-0374 | X3001-176F |
| 760 / AVT 1100 | 6400-207 | 200 | 1-1/4" BSP | Foot | • | 52200-2001 | SK230 | 816 | 836-0001 | SP6080-0374 | SP1005-04 |
| 760 / AVT 1100 | 52200-2001 | 200 | 1-1/2" BSP | Foot | • | 52200-2011 | SK407-0011 | 816 | 17935-0001 | SP6080-0374 | X3001-176F |
| 760 / AVT 1100 | 52200-2011 | 200 | 1-1/2" BSP | Foot | | | SK407-0011 | 816 | 17935-0001 | SP6080-0374 | X3001-176F |

LISTER, R.A. – See HAWKER SIDDELEY MARINE

| | | | | | | | | | | | |
|--|--|--|--|--|--|--|--|--|--|--|--|
| | | | | | | | | | | | |
|--|--|--|--|--|--|--|--|--|--|--|--|

LOMBARDINI – ITALY

| | | | | | | | | | | | |
|---------------------|------------|-----|----------|--------|---|------------|------------|------------|------------|-------------|------------|
| 672 / 673 / 674 | 11620-200 | 010 | 1/4" BSP | Flange | • | 22830-2101 | SK23 | 1189 | 4528-0001 | SP2701-11 | SP1002-01 |
| 832 / 833 / 834 | 11620-200 | 010 | 1/4" BSP | Flange | • | 22830-2101 | SK23 | 1189 | 4528-0001 | SP2701-11 | SP1002-01 |
| 832 / 833 / 834 | 22830-2101 | 010 | 3/8" BSP | Flange | • | | SK23 | 1189 | 4528-0001 | SP2701-14 | SP1002-01 |
| LDW 602M / LDW 903M | 29470-2231 | 020 | 3/8" BSP | Flange | • | | SK405-0001 | 29476-0000 | 18653-0001 | SP2701-1006 | X3004-095G |
| LDW 1204M | 29470-2531 | 020 | 3/8" BSP | Flange | • | | SK405-0001 | 29476-0000 | 18653-0001 | SP2701-1006 | X3004-095G |
| LDW 1503 | 29470-2431 | 020 | 3/8" BSP | Flange | • | | SK405-0001 | 29476-0000 | 18653-0001 | SP2701-1006 | X3004-095G |
| LDW 2004M / T | 29470-2431 | 020 | 3/8" BSP | Flange | • | | SK405-0001 | 29476-0000 | 18653-0001 | SP2701-1006 | X3004-095G |

MAN – GERMANY

| | | | | | | | | | | | |
|----------|------------|-----|-----------|-------|---|-----------|----------|------|------------|------------|-----------|
| D0224ME | 23020-1101 | 060 | Ø 32 Hose | Crank | | | SK331-05 | 3298 | 22120-0001 | SP6080-08B | SP8019-01 |
| D0226ME | 23020-1101 | 060 | Ø 32 Hose | Crank | | | SK331-05 | 3298 | 22120-0001 | SP6080-08B | SP8019-01 |
| D0226MLE | 23060-1101 | 060 | Ø 32 Hose | Crank | • | Dual Pump | SK360 | 3298 | 22120-0001 | SP6080-08B | SP1002-03 |
| D0226MTE | 23060-1101 | 060 | Ø 32 Hose | Crank | • | Dual Pump | SK360 | 3298 | 22120-0001 | SP6080-08B | SP1002-03 |

| JABSCO PUMP DETAILS | | | | | | | SERVICE KIT DETAILS | | | | |
|----------------------------|-------------------------|------|------------|------------|----------|-----------------------|---------------------|------------------|------------|-------------|------------------|
| MODEL NUMBER | MODEL NUMBER * OEM ONLY | SIZE | PORT SIZE | MOUNT TYPE | OBSOLETE | ALTERNATE PUMP NUMBER | NUMBER | END COVER GASKET | IMPELLER | WATER SEAL | END COVER SCREWS |
| D0826GLE40 / ML | 29600-1201 | 080 | Ø 32 Hose | Flange | | | SK385-0101 | 890 | 17937-0001 | SP6080-0469 | SP1003-0111 |
| D2530M / MT | 22040-0501 | 270 | 2" Flanged | Flange | | | SK318 | 816 | 21676-0001 | 21849 | SP1005-04 |
| D2540L / ML / MT | 22040-0501 | 270 | 2" Flanged | Flange | | | SK318 | 816 | 21676-0001 | 21849 | SP1005-04 |
| D2542L / ME / MLE / MTE | 23010-0531 | 080 | 1" BSP | Flange | • | Bilge | SK357-0001 | 11746 | 17937-0001 | 21849 | SP1005-03 |
| | Dual Pump | 270 | 2" Flange | Flange | | Cooling | SK357-0001 | 816 | 21676-0001 | 21849 | SP1005-03 |
| W4V 14 / 18 | 5400-205 | 200 | 1-1/4" BSP | Foot | • | 52200-2051 | | | | | |
| W6V 14 / 18 | 5400-205 | 200 | 1-1/4" BSP | Foot | • | 52200-2051 | | | | | |
| W3V 17.5 / 22A | 5400-205 | 200 | 1-1/4" BSP | Foot | • | 52200-2051 | | | | | |
| W3V 17.5 / 22A | 52200-2051 | 200 | 1-1/2" BSP | Foot | | | SK407-0011 | 816 | 17935-0001 | SP6080-0374 | X3001-176F |
| W4V 17.5 / 22A | 7870-251 | 200 | 1-1/4" BSP | Foot | • | | SK230 | 816 | 836-0001 | 21849 | SP1005-04 |
| W5V 17.5 / 22A | 7870-251 | 200 | 1-1/4" BSP | Foot | • | | SK230 | 816 | 836-0001 | 21849 | SP1005-04 |
| W6V 17.5 / 22A | 7870-251 | 200 | 1-1/4" BSP | Foot | • | | SK230 | 816 | 836-0001 | 21849 | SP1005-04 |
| W8V 17.5 / 22A | 7870-251 | 200 | 1-1/4" BSP | Foot | • | | SK230 | 816 | 836-0001 | 21849 | SP1005-04 |
| MERMAID MARINE – UK | | | | | | | | | | | |
| 105 / 130 | 21140-204 | 080 | 1" BSP | Flange | • | 21140-2401 | SK229 | 890 | 17937-0001 | 22626-6000 | SP1003-09 |
| 397 / 595 / ET / .INT | 21140-204 | 080 | 1" BSP | Flange | • | 21140-2401 | SK229 | 890 | 17937-0001 | 22626-6000 | SP1003-09 |
| 397 / 595 / ET / .INT | 21140-2401 | 080 | 1" BSP | Flange | | | SK229 | 890 | 17937-0001 | 22626-6000 | SP1003-09 |
| 595TP | 21580-200 | 080 | 1" BSP | Flange | • | | SK229 | 890 | 17937-0001 | 22626-6000 | SP1003-09 |
| Ford 2704 ET | 21580-200 | 080 | 1" BSP | Flange | • | | SK229 | 890 | 17937-0001 | 22626-6000 | SP1003-09 |
| Flat Four / Six | 21140-204 | 080 | 1" BSP | Flange | • | 21140-2401 | SK229 | 890 | 17937-0001 | 22626-6000 | SP1003-09 |
| Turbo Four | 21140-204 | 080 | 1" BSP | Flange | • | 21140-2401 | SK229 | 890 | 17937-0001 | 22626-6000 | SP1003-09 |
| Turbo Four | 21140-2401 | 080 | 1" BSP | Flange | | | SK229 | 890 | 17937-0001 | 22626-6000 | SP1003-09 |
| Turbo Plus | 21140-2641 | 080 | 1" BSP | Flange | • | | SK229 | 890 | 17937-0001 | 22626-6000 | SP1003-09 |
| Mariner 2715E | 21140-2441 | 080 | 1" BSP | Flange | • | | SK229 | 890 | 17937-0001 | 22626-6000 | SP1003-09 |
| Mariner 2720E | 21140-2641 | 080 | 1" BSP | Flange | • | | SK229 | 890 | 17937-0001 | 22626-6000 | SP1003-09 |
| Magnum | 29700-1201 | 120 | Ø 45 Hose | Flange | | | SK386-0001 | 890 | 17018-0001 | SP6080-0469 | SP1003-0111 |
| Majestic | 21140-2641 | 080 | 1" BSP | Flange | • | | SK229 | 890 | 17937-0001 | 22626-6000 | SP1003-09 |

11 Flexible Impeller Pumps

COOLING PUMP SPARES BY MAKE OF ENGINE



| JABSCO PUMP DETAILS | | | | | | | SERVICE KIT DETAILS | | | | |
|---------------------|-------------------------|------|-----------|------------|----------|-----------------------|---------------------|------------------|------------|-------------|------------------|
| MODEL NUMBER | MODEL NUMBER * OEM ONLY | SIZE | PORT SIZE | MOUNT TYPE | OBSOLETE | ALTERNATE PUMP NUMBER | NUMBER | END COVER GASKET | IMPELLER | WATER SEAL | END COVER SCREWS |
| Manta | 23430-1201 | 080 | Ø 32 Hose | Flange | | | SK385-0001 | 890 | 17937-0001 | SP2700-1027 | SP1003-0111 |
| Meermin | 52040-2001 | 040 | 3/4" BSP | Foot | | | SK384-0101 | 3298 | 1210-0001 | SP2701-1015 | X3001-095F |
| Melody | 21140-2641 | 080 | 1" BSP | Flange | • | | SK229 | 890 | 17937-0001 | 22626-6000 | SP1003-09 |
| Merlin FSD | 52040-2001 | 040 | 3/4" BSP | Foot | | | SK384-0101 | 3298 | 1210-0001 | SP2701-1015 | X3001-095F |
| Merlin FSD | 29500-1201 | 040 | Ø 28 Hose | Flange | | | SK384-0001 | 3298 | 1210-0001 | SP2700-1027 | SP1002-02 |
| Merlin Turbo | 22750-1101 | 060 | Ø 32 Hose | Crank | • | | SK331-05 | 3298 | 22120-0001 | SP2701-21 | SP8019-01 |
| Meteor XLD | 22770-1101 | 020 | Ø 25 Hose | Crank | • | 29440-1101 | SK346 | 1985-01 | 673-0001 | SP2701-21 | SP1004-09 |
| Meteorite | 22770-1101 | 020 | Ø 25 Hose | Crank | • | 29440-1101 | SK346 | 1985-01 | 673-0001 | SP2701-21 | SP1004-09 |
| Meteorite | 29440-1101 | 020 | Ø 25 Hose | Crank | | | SK402-0001 | 1985-0000 | 18653-0001 | 29441-0000 | SP1004-09 |
| Minuet | 52040-2001 | 040 | 3/4" BSP | Foot | | | SK384-0101 | 3298 | 1210-0001 | SP2701-1015 | X3001-095F |
| Mistral | 21140-2641 | 080 | 1" BSP | Flange | • | | SK229 | 890 | 17937-0001 | 22626-6000 | SP1003-09 |
| Monarch | 21140-2641 | 080 | 1" BSP | Flange | • | | SK229 | 890 | 17937-0001 | 22626-6000 | SP1003-09 |

MITSUBISHI

| | | | | | | | | | | | |
|----------------------------------|------------|-----|-----------|--------|---|-------------|------------|------------|------------|-------------|-------------|
| K 2AS | 52010-2001 | 010 | 3/8" NPTF | Foot | • | 51510-2001 | SK404-0101 | 29308-0000 | 22405-0001 | SP2701-0501 | X3001-095F |
| K 2C | 29470-2351 | 020 | 3/8" BSP | Flange | • | 29470-2351C | SK405-0001 | 29476-0000 | 18653-0001 | SP2701-1006 | X3004-095G |
| K 3M | 29470-2331 | 020 | 3/8" BSP | Flange | • | 29470-2331C | SK405-0001 | 29476-0000 | 18653-0001 | SP2701-1006 | X3004-095G |
| K 3E / 4E | 29470-2351 | 020 | 3/8" BSP | Flange | • | 29470-2351C | SK405-0001 | 29476-0000 | 18653-0001 | SP2701-1006 | X3004-095G |
| S 4E2 | 23430-1041 | 080 | Ø 32 Hose | Flange | • | | SK385-0001 | 890 | 17937-0001 | SP2700-1027 | SP1003-0111 |
| S 6E2 | 23430-1041 | 080 | Ø 32 Hose | Flange | • | | SK385-0001 | 890 | 17937-0001 | SP2700-1027 | SP1003-0111 |
| S 6E2 | 23430-1001 | 080 | Ø 32 Hose | Flange | | | SK385-0001 | 890 | 17937-0001 | SP2700-1027 | SP1003-0111 |
| 4 DQ50 | 23430-1051 | 080 | Ø 32 Hose | Flange | • | | SK385-0001 | 890 | 17937-0001 | SP2700-1027 | SP1003-0111 |
| 4 DQ50 | 23430-1041 | 080 | Ø 32 Hose | Flange | • | | SK385-0001 | 890 | 17937-0001 | SP2700-1027 | SP1003-0111 |
| K & L Series, 2-, 3-, 4-cylinder | 29400-1101 | | | | • | | | | | | |

MWM – GERMANY

| | | | | | | | | | | | |
|----------------|-------------|-----|----------|--------|---|----------|----------|------|-----------|------------|-----------|
| KD 1105 Z | 9970-241-37 | 040 | 3/4" BSP | Flange | | | SK239-37 | 3298 | 1210-0003 | 22626-6000 | SP1002-02 |
| KD 1105 D | 9970-241-37 | 040 | 3/4" BSP | Flange | | | SK239-37 | 3298 | 1210-0003 | 22626-6000 | SP1002-02 |
| KD 1105 V | 9970-241-37 | 040 | 3/4" BSP | Flange | | | SK239-37 | 3298 | 1210-0003 | 22626-6000 | SP1002-02 |
| KD 1105 S | 9970-241-37 | 040 | 3/4" BSP | Flange | | | SK239-37 | 3298 | 1210-0003 | 22626-6000 | SP1002-02 |
| D 208 | 9970-241-37 | 040 | 3/4" BSP | Flange | | | SK239-37 | 3298 | 1210-0003 | 22626-6000 | SP1002-02 |
| TKD 1105 V & S | 9970-251 | 040 | 3/4" BSP | Flange | • | 9970-241 | SK239 | 3298 | 1210-0001 | 22626-6000 | SP1002-02 |

| JABSCO PUMP DETAILS | | | | | | | SERVICE KIT DETAILS | | | | |
|--|-------------------------|------|----------------|------------|----------|-----------------------|---------------------|------------------|------------|-------------|------------------|
| MODEL NUMBER | MODEL NUMBER * OEM ONLY | SIZE | PORT SIZE | MOUNT TYPE | OBSOLETE | ALTERNATE PUMP NUMBER | NUMBER | END COVER GASKET | IMPELLER | WATER SEAL | END COVER SCREWS |
| KD 1105 | 9970-251 | 040 | 3/4" BSP | Flange | • | 9970-241 | SK239 | 3298 | 1210-0001 | 22626-6000 | SP1002-02 |
| TD 208-4 & 6 | 9970-251 | 040 | 3/4" BSP | Flange | • | 9970-241 | SK239 | 3298 | 1210-0001 | 22626-6000 | SP1002-02 |
| D 2086 | 9970-251 | 040 | 3/4" BSP | Flange | • | 9970-241 | SK239 | 3298 | 1210-0001 | 22626-6000 | SP1002-02 |
| D 2086 | 9970-241 | 040 | 3/4" BSP | Flange | | Direct Cooling | SK241 | 3298 | 1210-0001 | 22626-6000 | SP1002-02 |
| D 225 4 & 6 | 9970-241-37 | 040 | 3/4" BSP | Flange | | | SK239-37 | 3298 | 1210-0003 | 22626-6000 | SP1002-02 |
| D226-2 -3 -4 & 6 | 9970-241 | 040 | 3/4" BSP | Flange | | Direct Cooling | SK241 | 3298 | 1210-0001 | 22626-6000 | SP1002-02 |
| TD 226-6 | 9970-241 | 040 | 3/4" BSP | Flange | | Direct Cooling | SK241 | 3298 | 1210-0001 | 22626-6000 | SP1002-02 |
| TD 228-6 | 9970-241 | 040 | 3/4" BSP | Flange | | Direct Cooling | SK241 | 3298 | 1210-0001 | 22626-6000 | SP1002-02 |
| TD 226-6 | 22220-241 | 060 | 1" BSP | Flange | | | SK334 | 3298 | 22120-0001 | 22626-6000 | SP1002-01 |
| TD 228-6 | 22220-241 | 060 | 1" BSP | Flange | | | SK334 | 3298 | 22120-0001 | 22626-6000 | SP1002-01 |
| D202-283 | 22830-2051 | 010 | 3/8" BSP | Flange | • | | SK23 | 1189 | 4528-0001 | SP2701-14 | SP1002-01 |
| 234B | 29880-0001 | 370 | 2-3/4" Flanged | Flange | | Respecified | SK410 | X4020-424A | 17240-0001 | 21849 | X3001-180F |
| D889 / 90 / 91 / 92 / 93 | 22820-2051 | 040 | 3/8" BSP | Flange | • | | SK23 | 1189 | 4528-0001 | SP2701-14 | SP1002-01 |
| NANNI DIESEL – FRANCE / HOLLAND | | | | | | | | | | | |
| FK2 / 2.40 HE | 29300-2001 | 010 | 3/8" BSP | Flange | • | | SK404-0001 | 29308-0000 | 22405-0001 | SP2701-1006 | X3004-095G |
| FK3 / 2.60 HE / 3.90 HE | 29470-2031 | 020 | 3/8" BSP | Flange | • | | SK405-0001 | 29476-0000 | 18653-0001 | SP2701-1006 | X3004-095G |
| K.L.A | 29300-2301 | 010 | 3/8" BSP | Flange | • | | SK404-0001 | 29308-0000 | 22405-0001 | SP2701-1006 | X3004-095G |
| L30 | 52010-2001 | 010 | 3/8" NPTF | Foot | • | 51510-2001 | SK404-0101 | 29308-0000 | 22405-0001 | SP2701-0501 | X3001-095F |
| P 30 / R 30 / S 30 | 29470-2031 | 020 | 3/8" BSP | Flange | • | | SK405-0001 | 29476-0000 | 18653-0001 | SP2701-1006 | X3004-095G |
| P 30 / R 30 / S 30 | 52020-2031 | 020 | 1/2" BSP | Foot | | | SK405-0101 | 2995-0030 | 18653-0001 | SP2701-0501 | X3001-095F |
| RC 210 D | 11740-205 | 080 | 1" BSP | Foot | • | Bilge | SK300 | 11746 | 17937-0001 | 21849 | SP1005-03 |
| RC 320 D | Dual Pump | 200 | 1-1/2" Flanged | Foot | | Cooling | SK300 | 816 | 836-0001 | 21849 | SP1005-03 |
| 2.40HE | 29300-2001C | 010 | 3/8" BSP | Flange | • | | SK404-0001 | 29308-0000 | 22405-0001 | SP2701-1006 | X3004-095G |
| 2.50HE | 29460-1401 | 020 | Ø 20 Hose | Flange | • | 29460-1631 | SK401-0001 | 2995-0030 | 18653-0001 | SP2701-1006 | SP1002-01 |
| 2.60 | 11260-2101 | 010 | 3/8" BSP | Flange | • | 29300-2201C | SK266 | 1126 | 4528-0001 | SP2701-04 | SP1002-01 |
| 2.60HE | 29470-2031C | 020 | 3/8" BSP | Flange | | | SK405-0001 | 29476-0000 | 18653-0001 | SP2701-1006 | X3004-095G |
| 3.75HE | 29460-1401 | 020 | Ø 20 Hose | Flange | • | 29460-1631 | SK401-0001 | 2995-0030 | 18653-0001 | SP2701-1006 | SP1002-01 |

11 Flexible Impeller Pumps

COOLING PUMP SPARES BY MAKE OF ENGINE



| JABSCO PUMP DETAILS | | | | | | | SERVICE KIT DETAILS | | | | |
|---------------------|-------------------------|------|----------------|------------|----------|-----------------------|---------------------|------------------|------------|-------------|------------------|
| MODEL NUMBER | MODEL NUMBER * OEM ONLY | SIZE | PORT SIZE | MOUNT TYPE | OBSOLETE | ALTERNATE PUMP NUMBER | NUMBER | END COVER GASKET | IMPELLER | WATER SEAL | END COVER SCREWS |
| 3.90 | 11260-2101 | 010 | 3/8" BSP | Flange | • | 29300-2201C | SK266 | 1126 | 4528-0001 | SP2701-04 | SP1002-01 |
| 3.90 | 29300-2201C | 010 | 3/8" BSP | Flange | • | | SK404-0001 | 29308-0000 | 22405-0001 | SP2701-1006 | X3004-095G |
| 3.90 | 21130-2101 | 020 | 3/8" BSP | Flange | • | Bilge | SK304 | 21117 | 4528-0001 | SP2701-04 | SP1002-03 |
| | Dual Pump | 020 | 3/8" BSP | Flange | | Cooling | SK304 | 21117 | 4528-0001 | SP2701-04 | SP1002-17 |
| 3.90HE | 29470-2031 | | | | • | | | | 18653-0001 | | |
| 4.110 HE | 3270-261 | 040 | 3/4" BSP | Flange | • | | SK33 | 3298 | 1210-0001 | SP2701-21 | SP1002-02 |
| 4.110HLE | 3270-261 | 040 | 3/4" BSP | Flange | | | SK33 | 3298 | 1210-0001 | SP2701-21 | SP1002-02 |
| 4.18 | 3270-261 | 040 | 3/4" BSP | Flange | | | SK33 | 3298 | 1210-0001 | SP2701-21 | SP1002-02 |
| 4.180 | 3270-261 | 040 | 3/4" BSP | Flange | • | | SK33 | 3298 | 1210-0001 | SP2701-21 | SP1002-02 |
| 4.190 HE | 29500 | 040 | Ø 28 Hose | Flange | • | | SK384-0001 | 3298 | 1210-0001 | SP2700-1027 | SP1002-02 |
| 4.220 HE | 23430-1001 | 080 | Ø 32 Hose | Flange | | | SK385-0001 | 890 | 17937-0001 | SP2700-1027 | SP1003-0111 |
| 4.440 | 29600-1201 | 080 | Ø 32 Hose | Flange | | | SK385-0101 | 890 | 17937-0001 | SP6080-0469 | SP1003-0111 |
| 5.280 HE | 23430-1001 | 080 | Ø 32 Hose | Flange | | | SK385-0001 | 890 | 17937-0001 | SP2700-1027 | SP1003-0111 |
| 6.280 | 23430-1001 | 080 | Ø 32 Hose | Flange | | | SK385-0001 | 890 | 17937-0001 | SP2700-1027 | SP1003-0111 |
| 6.570 / T | 6420-2041 | 080 | 1" BSP | Foot | • | 52080-2041 | SK385-0201 | 3101 | 17937-0001 | SP2700-1027 | SP1003-09 |
| 6.570 / T | 52080-2041 | 080 | 1" BSP | Foot | | | SK406-0001 | 890 | 17937-0001 | SP2700-48 | X3001-147F |
| 6.660E / 6.660 LE | 29600-1201 | 080 | Ø 32 Hose | Flange | | | SK385-0101 | 890 | 17937-0001 | SP6080-0469 | SP1003-0111 |
| MB 180 / 300 | 29500-1001 | 040 | Ø 28 Hose | Flange | | | SK384-0001 | 3298 | 1210-0001 | SP2700-1027 | SP1002-02 |
| MB 220 | 3270-205 | 040 | 3/4" BSP | Flange | • | | SK33 | 3298 | 1210-0001 | SP2701-21 | SP1002-02 |
| OM 366 | 23340-1101 | 120 | Ø 45 Hose | Flange | • | Respecified | SK310 | 890 | 17018-0001 | 22617-0000 | SP1003-09 |
| 1300 | 52220-0041 | 200 | 1-1/2" Flanged | Foot | | | SK407-0011 | 816 | 17935-0001 | SP6080-0374 | X3001-176F |
| 1600 | 52220-0011 | 200 | 1-1/2" Flanged | Foot | | | SK407-0011 | 816 | 17935-0001 | SP6080-0374 | X3001-176F |
| 2100 | 52270-2041 | 270 | 2" BSP | Foot | | | SK408-0011 | 816 | 21676-0001 | SP6080-0374 | X3001-176F |
| 2100 T | 52270-2011 | 270 | 2" BSP | Foot | | | SK408-0011 | 816 | 17936-0001 | SP6080-0374 | X3001-176F |
| NORPRO – USA | | | | | | | | | | | |
| 1120A | 2620-1001 | | 3/8" NPTF | Foot | • | | 90020-0001 | 18753-0125 | 18673-0001 | 92700-0050 | 18753-0121 |
| 1731 | 2620-1001 | | 3/8" NPTF | Foot | • | | 90020-0001 | 18753-0125 | 18673-0001 | 92700-0050 | 18753-0121 |
| 600 | 2620-1001 | | 3/8" NPTF | Foot | • | | 90020-0001 | 18753-0125 | 18673-0001 | 92700-0050 | 18753-0121 |
| 800 | 2620-1001 | | 3/8" NPTF | Foot | • | | 90020-0001 | 18753-0125 | 18673-0001 | 92700-0050 | 18753-0121 |

| JABSCO PUMP DETAILS | | | | | | | SERVICE KIT DETAILS | | | | |
|-------------------------------|-------------------------|------|------------|------------|----------|-----------------------|---------------------|--------------------------------------|------------|-------------|------------------|
| MODEL NUMBER | MODEL NUMBER * OEM ONLY | SIZE | PORT SIZE | MOUNT TYPE | OBSOLETE | ALTERNATE PUMP NUMBER | NUMBER | END COVER GASKET | IMPELLER | WATER SEAL | END COVER SCREWS |
| 1000 | 2620-1001 | | 3/8" NPTF | Foot | • | | 90020-0001 | 18753-0125 | 18673-0001 | 92700-0050 | 18753-0121 |
| 1250 | 2620-1001 | | 3/8" NPTF | Foot | • | | 90020-0001 | 18753-0125 | 18673-0001 | 92700-0050 | 18753-0121 |
| 1800 | 2620-1001 | | 3/8" NPTF | Foot | • | | 90020-0001 | 18753-0125 | 18673-0001 | 92700-0050 | 18753-0121 |
| 6500T2 | 777-9001 | | 1" NPTF | Foot | | | 90118-0001 | 890-0000 | 920-0001 | 96080-0001 | 91003-0010 |
| NORTH EAST FORD – USA | | | | | | | | | | | |
| Ford | | | | | | | | | | | |
| 2723 | 21140-2601 | 080 | 1" BSP | Flange | | | SK229 | 890 | 17937-0001 | 22626-6000 | SP1003-09 |
| ONAN – USA | | | | | | | | | | | |
| Ensign | 52010-0051 | 010 | 3/8" NPT | Foot | • | | SK404-0101 | 29308-0000 | 22405-0001 | SP2701-0501 | X3001-095F |
| 9 kW | 52010-0051 | 010 | 3/8" NPT | Foot | • | | SK404-0101 | 29308-0000 | 22405-0001 | SP2701-0501 | X3001-095F |
| PEGASO (ENASA) – SPAIN | | | | | | | | | | | |
| 9040 / 9028 | 9710-200 | 080 | 1" BSP | Foot | | | SK229 | 890 | 17937-0001 | 22626-6000 | SP1003-09 |
| 9100 / 4 / 5 | 9710-200 | 080 | 1" BSP | Foot | | | SK229 | 890 | 17937-0001 | 22626-6000 | SP1003-09 |
| 9130 / S | 9700-21 | 080 | 1" Flanged | Flange | | 29600-1001 | SK238 | 890 | 17937-0001 | SP6080-06 | SP1003-01 |
| 9130 / S | 29600-1001 | 080 | Ø 32 Hose | Flange | | New Pipework | SK385-0101 | 890 | 17937-0001 | SP6080-0469 | SP1003-0111 |
| 9716 / S | 6490-252 | 040 | 1/2" BSP | Foot | • | 6490-222 | SK225-01 | Use 23299 Kit to upgrade to 6490-222 | | | |
| 9716 / S | 6490-222 | 040 | 1/2" BSP | Foot | • | | SK225-01 | 6496 | 1210-0001 | SP2701-21 | SP1003-09 |
| PERAMA | | | | | | | | | | | |
| M20 | 29350-1001 | 010 | Ø 18 Hose | Flange | | | SK23-0101 | 1126 | 4528-0001 | SP2701-14 | SP1002-01 |
| M25 / 30 / 3HD 20 | 29450-1101 | 020 | Ø 20 Hose | Flange | • | | SK387-0001 | 2995-0030 | 673-0001 | SP2700-05 | SP1002-01 |
| M35 / 40 | 29450-1101 | 020 | Ø 20 Hose | Flange | • | | SK387-0001 | 2995-0030 | 673-0001 | SP2700-05 | SP1002-01 |
| MC42 | 29450-1231 | 020 | Ø 20 Hose | Flange | | | SK387-0001 | 2995-0030 | 673-0001 | SP2700-05 | SP1002-01 |
| 3HD 46 | 29450-1201 | 020 | Ø 20 Hose | Flange | | | SK387-0001 | 2995-0030 | 673-0001 | SP2700-05 | SP1002-01 |
| M50 / 60 / 80T | 29450-1201 | 020 | Ø 20 Hose | Flange | | | SK387-0001 | 2995-0030 | 673-0001 | SP2700-05 | SP1002-01 |
| Prima | 29500-1001 | 040 | Ø 28 Hose | Flange | | | SK384-0001 | 3298 | 1210-0001 | SP2700-1027 | SP1002-02 |
| Primera (MD22) | 29540-1001 | 040 | Ø 28 Hose | Foot | • | | SK384-0001 | 3298 | 1210-0001 | SP2700-1027 | X3001-095F |
| PERKINS – UK | | | | | | | | | | | |
| P3 144M / 152M | 4850 | 080 | Ø 32 Hose | Flange | • | 9750 | | 3101 | 920-08 | SP2700-06 | SP1003-09 |
| P3 144M / 152M | 9750 | 080 | Ø 32 Hose | Flange | • | | SK269 | 3101-01 | 17937-0001 | 22626-6000 | SP1003-09 |

11 Flexible Impeller Pumps

COOLING PUMP SPARES BY MAKE OF ENGINE



| JABSCO PUMP DETAILS | | | | | | | SERVICE KIT DETAILS | | | | |
|-------------------------|-------------------------|------|-------------------|------------|----------|-----------------------|---------------------|------------------|------------|-------------|------------------|
| MODEL NUMBER | MODEL NUMBER * OEM ONLY | SIZE | PORT SIZE | MOUNT TYPE | OBSOLETE | ALTERNATE PUMP NUMBER | NUMBER | END COVER GASKET | IMPELLER | WATER SEAL | END COVER SCREWS |
| P3 144M / 152M | 4860 | 080 | Ø 32 Hose | Flange | • | 9760 | | 3101 | 920-08 | SP2700-06 | SP1003-09 |
| P3 144M / 152M | 9760 | 080 | Ø 32 Hose | Flange | • | | SK269 | 890-01 | 17937-0001 | 22626-6000 | SP1003-09 |
| P3M / P4M / P6M | 4330-01 | 080 | Ø 32 Hose/ Flange | Flange | • | | | | | | |
| 4.99M | 29500-1001 | 040 | Ø 28 Hose | Flange | | | SK384-0001 | 3298 | 1210-0001 | SP2700-1027 | SP1002-02 |
| 4.99M (Exhaust Cooling) | 9430 | 010 | 1/4" BSP | Flange | • | Exhaust Cooling | SK221 | 1126 | 4528-0001 | SP2701-09 | SP1002-01 |
| L4M | 4160 | 080 | Ø 32 Hose | Flange | • | | | | | | |
| S6M / 31.52 / 3.1524 | 6420-2001 | 080 | 1" BSP | Foot | • | 52080-2001 | SK385-0201 | 890 | 17937-0001 | SP2700-1027 | SP1003-09 |
| S6M / 31.52 / 3.1524 | 52080-2001 | 080 | 1" BSP | Foot | | | SK406-0001 | 890 | 17937-0001 | SP2700-48 | X3001-147F |
| 3.152 / 3.1524 | 29500-1101 | 040 | Ø 28 Hose | Flange | | | SK384-0001 | 3298 | 1210-0001 | SP2700-1027 | SP1002-02 |
| 4.107M / 4.108M / LL | 3370-200 | 040 | 3/4" BSP | Flange | • | 9970-200 | SK33 | 3298 | 1210-0001 | SP2701-21 | SP1002-02 |
| 4.107M / 4.108M / LL | 9970-200 | 040 | 3/4" BSP | Flange | | | SK229 | 3298 | 1210-0001 | 22626-6000 | SP1002-02 |
| 4114 (Imp. from USA) | 11850-0101 | 040 | 1" Hose | Flange | • | 11850-0701 | SK117-02 | 8641 | 1210-0001 | SP6080-08B | SP1026-01 |
| 4114 (Imp. from USA) | 11850-0701 | 040 | 1" Hose | Flange | • | | SK117-02 | 8641 | 1210-0001 | SP6080-08B | SP1026-01 |
| 4.236 / T4.236 | 10970 | 040 | 3/4" BSP | Flange | | | SK268-01 | 3298 | 1210-0001 | 22626-6000 | SP1002-02 |
| 4.236 LL | 10970-21 | 040 | 3/4" Flanged | Flange | | | SK268-01 | 3298 | 1210-0001 | 22626-6000 | SP1002-02 |
| 4.270 M | 4160 | 080 | Ø 32 Hose | Flange | • | | | | | | |
| 6.305 M | 6030-71 | 080 | 1" Flanged | Flange | • | | SK236 | 890 | 17937-0001 | SP2701-21 | SP1003-09 |
| T / H / HT 6.354 M | 9990-21 | 040 | 3/4" NPT | Barrel | • | 9990-41 | | 3298 | 1210-0001 | 22626-6000 | SP1002-02 |
| T / H / HT 6.354 M | 9990-41 | 040 | 3/4" NPT | Barrel | | | SK268 | 3298 | 1210-0001 | 22626-6000 | SP1002-02 |
| T / H / HT 6.354 LL | 9700-151 | 080 | 1" Flanged | Flange | • | | SK238-01 | 3101 | 17937-0001 | SP6080-06 | SP1003-01 |
| 6.3540 M | 9700-151 | 080 | 1" Flanged | Flange | • | | SK238-01 | 3101 | 17937-0001 | SP6080-06 | SP1003-01 |
| 6.3543 M | 9700-141 | 080 | 1" Flanged | Flange | • | 9700-04 | SK238 | 890 | 17937-0001 | SP6080-06 | SP1003-01 |
| 6.3543 M | 9700-04 | 080 | 1" Flanged | Flange | | | SK238-01 | 3101 | 17937-0001 | SP6080-06 | SP1003-01 |
| 6.354 | 9700-01 | 080 | 1" Flanged | Flange | | | SK238 | 890 | 17937-0001 | SP6080-06 | SP1003-01 |
| V8.510 | 21180-05 | 200 | 1-1/4" Flanged | Flange | • | | SK293-01 | 816 | 836-0001 | 21849 | SP1005-04 |
| TV8.5410 / 40 | 21180 | 200 | 1-1/4" Flanged | Flange | • | | SK293-01 | 816 | 836-0001 | 21849 | SP1005-04 |
| M90 / 4HD 76 / 6HD | 10970-21 | 040 | 3/4" Flanged | Flange | | | SK268-01 | 3298 | 1210-0001 | 22626-6000 | SP1002-02 |
| 6HD 135 / 150 | 9700-01 | 080 | 1" Flanged | Flange | | | SK238 | 890 | 17937-0001 | SP6080-06 | SP1003-01 |
| M200 / 240 / 275 | 9990-41 | 040 | 3/4" NPT | Barrel | | | SK268 | 3298 | 1210-0001 | 22626-6000 | SP1002-02 |

| JABSCO PUMP DETAILS | | | | | | | SERVICE KIT DETAILS | | | | |
|-----------------------------|-------------------------|------|----------------|------------|----------|-----------------------|---------------------|------------------|------------|-------------|------------------|
| MODEL NUMBER | MODEL NUMBER * OEM ONLY | SIZE | PORT SIZE | MOUNT TYPE | OBSOLETE | ALTERNATE PUMP NUMBER | NUMBER | END COVER GASKET | IMPELLER | WATER SEAL | END COVER SCREWS |
| 1000-Series | 29630-1001 | 080 | Ø 32 Hose | Flange | • | | SK385-0101 | 890 | 17937-0001 | SP6080-0469 | SP1003-0111 |
| POWER GENNY – USA | | | | | | | | | | | |
| Kubota 2-cyl. | 52010-2001 | 010 | 3/8" NPTF | Foot | • | 51510-2001 | SK404-0101 | 29308-0000 | 22405-0001 | SP2701-0501 | X3001-095F |
| ROLLS ROYCE – UK | | | | | | | | | | | |
| C6NFLM / C6SFLM | 4360 | 200 | 1-1/2" Flanged | Flange | • | | SK230 | 816 | 836-0001 | 21849 | SP1005-04 |
| C8T Mk IV | 4360 | 200 | 1-1/2" Flanged | Flange | • | | SK230 | 816 | 836-0001 | 21849 | SP1005-04 |
| C8T / C8S / C8N | 10590-01 | 270 | 2" Flanged | Flange | • | | SK254 | 816 | 21676-0001 | 21849 | SP1005-04 |
| C6-Series / C12-Series | 10590-01 | 270 | 2" Flanged | Flange | • | | SK254 | 816 | 21676-0001 | 21849 | SP1005-04 |
| CV-Series / 8 / 12HD | 10590-01 | 270 | 2" Flanged | Flange | • | | SK254 | 816 | 21676-0001 | 21849 | SP1005-04 |
| CV-Series / 8 / 12HD | 11100-01-01 | 270 | 2" BSP | Flange | • | | SK254 | 816 | 21676-0001 | 21849 | SP1005-04 |
| SAAB – NORWAY | | | | | | | | | | | |
| F 210 / F 444 | 21690 | 040 | Ø 20 Hose | Flange | • | | SK239 | 3298 | 1210-0001 | 22626-6000 | SP1002-02 |
| F 210 / F 444 | 21690-05 | 040 | Ø 20 Hose | Flange | • | | SK239 | 3298 | 1210-0001 | 22626-6000 | SP1002-02 |
| F 4.254 / 6.380 | 10950-201 | 040 | 1/2" BSP | Flange | • | 10950-2401 | SK239 | 3298 | 1210-0001 | 22626-6000 | SP1002-02 |
| F 4.254 / 6.380 | 10950-2401 | 040 | 3/4" BSP | Flange | | | SK239 | 3298 | 1210-0001 | 22626-6000 | SP1002-02 |
| F 6.363T / TI | 21140-201 | 080 | 1" BSP | Flange | • | 21140-2401 | SK229 | 890 | 17937-0001 | 22626-6000 | SP1003-09 |
| F 6.363T / TI | 21140-2401 | 080 | 1" BSP | Flange | | | SK229 | 890 | 17937-0001 | 22626-6000 | SP1003-09 |
| M 4.210 | 3270-2101 | 040 | 3/4" BSP | Flange | • | | SK271 | 3298 | 1210-0001 | SP2701-21 | SP1002-02 |
| M 4.295 | 29500-1001 | 040 | Ø 28 Hose | Flange | | | SK384-0001 | 3298 | 1210-0001 | SP2700-1027 | SP1002-02 |
| SAAB SCANIA – SWEDEN | | | | | | | | | | | |
| D11 / DS11 / DSI11 | 10980-01 | 200 | 1-1/2" Flanged | Flange | • | 10980-0051 | SK230 | 816 | 836-0001 | 21849 | SP1005-04 |
| D11 / DS11 / DSI11 | 10980-0051 | 200 | 1-1/2" Flanged | Flange | • | | SK230-0161 | 816 | 17935-0001 | 21849 | SP1005-04 |
| D5 / DS5 | 9700-21 | 080 | 1" Flanged | Flange | | 29600-1001 | SK238 | 890 | 17937-0001 | SP6080-06 | SP1003-01 |
| D5 / DS5 | 29600-1001 | 080 | Ø 32 Hose | Flange | | New Pipework | SK385-0101 | 890 | 17937-0001 | SP6080-0469 | SP1003-0111 |
| D5 / DS5 | 7870-221 | 200 | 1-1/4" BSP | Foot | • | | SK230 | 816 | 836-0001 | SP6080-0374 | SP1005-04 |
| SABRE ENGINES – UK | | | | | | | | | | | |
| Ford Dorset | | | | | | | | | | | |
| 80 / 120 / 140 | 10950-200 | 040 | 3/4" BSP | Flange | • | 10950-2401 | SK239 | 3298 | 1210-0001 | 22626-6000 | SP1002-02 |
| 80 / 120 / 140 | 10950-2401 | 040 | 3/4" BSP | Flange | | | SK239 | 3298 | 1210-0001 | 22626-6000 | SP1002-02 |

11 Flexible Impeller Pumps

COOLING PUMP SPARES BY MAKE OF ENGINE



| JABSCO PUMP DETAILS | | | | | | | SERVICE KIT DETAILS | | | | |
|------------------------|-------------------------|------|----------------|------------|----------|-----------------------|---------------------|------------------|------------|-------------|------------------|
| MODEL NUMBER | MODEL NUMBER * OEM ONLY | SIZE | PORT SIZE | MOUNT TYPE | OBSOLETE | ALTERNATE PUMP NUMBER | NUMBER | END COVER GASKET | IMPELLER | WATER SEAL | END COVER SCREWS |
| 180 / 210 / 212 / 212C | 21140-200 | 080 | 1" BSP | Flange | • | 21140-2401 | SK229 | 890 | 17937-0001 | 22626-6000 | SP1003-09 |
| 180 / 210 / 212 / 212C | 21140-2401 | 080 | 1" BSP | Flange | | | SK229 | 890 | 17937-0001 | 22626-6000 | SP1003-09 |
| Ford Dover | 21140-2201 | 080 | 1" BSP | Flange | • | 21140-2601 | SK229 | 890 | 17937-0001 | 22626-6000 | SP1003-09 |
| Ford Dover | 21140-2601 | 080 | 1" BSP | Flange | | | SK229 | 890 | 17937-0001 | 22626-6000 | SP1003-09 |
| 250 / 275 / 365 | 21580-200 | 080 | 1" BSP | Flange | • | | SK229 | 890 | 17937-0001 | 22626-6000 | SP1003-09 |
| Marathon | 21890 | 120 | 1-1/2" BSP | Flange | • | 10880-2611 | SK310 | 890 | 17018-0001 | 22617-0000 | SP1003-09 |
| Marathon | 10880-2611 | 200 | 1-1/2" Flanged | Flange | • | | SK375-0101 | 816 | 17935-0001 | 21849 | SP1005-04 |
| M225Ti / 370Ti | 29630-1001 | 080 | Ø 32 Hose | Flange | • | | SK385-0101 | 890 | 17937-0001 | SP6080-0469 | SP1003-0111 |
| 370L / 420L | 29700-1201 | 120 | Ø 45 Hose | Flange | | | SK386-0001 | 890 | 17018-0001 | SP6080-0469 | SP1003-0111 |
| 320 / 400 / 420 / 450 | 10630-07 | 200 | 1-1/2" Flanged | Foot | • | 52220-0011 | SK230 | 816 | 836-0001 | 21849 | SP1005-04 |
| 320 / 400 / 420 / 450 | 52220-0011 | 200 | 1-1/2" Flanged | Foot | | | SK407-0011 | 816 | 17935-0001 | SP6080-0374 | X3001-176F |
| 500 | 10490-07 | 270 | 2" Flanged | Foot | • | 52270-0011 | SK254 | 816 | 21676-0001 | 21849 | SP1005-04 |
| 500 | 52270-0011 | 270 | 2" Flanged | Foot | | | SK408-0011 | 816 | 17936-0001 | SP6080-0374 | SP1095-0640 |
| M215C | 29630-1001 | 080 | Ø 32 Hose | Flange | • | | SK385-0101 | 890 | 17937-0001 | SP6080-0469 | SP1003-0111 |
| M185C | 29630-1001 | 080 | Ø 32 Hose | Flange | • | | SK385-0101 | 890 | 17937-0001 | SP6080-0469 | SP1003-0111 |
| M130C | 29630-1001 | 080 | Ø 32 Hose | Flange | • | | SK385-0101 | 890 | 17937-0001 | SP6080-0469 | SP1003-0111 |
| M135 | 29630-1001 | 080 | Ø 32 Hose | Flange | • | 29640-1101 | SK385-0101 | 890 | 17937-0001 | SP6080-0469 | SP1003-0111 |
| 1006T | 29630-1201* | 080 | Ø 32 Hose | Flange | | | SK385-0601 | 890 | 920-0101 | SP6080-0469 | X5258-013 |
| 1006NA | 29630-1241* | 080 | Ø 32 Hose | Flange | | | SK385-0601 | 890 | 920-0101 | SP6080-0469 | X5258-013 |
| 1104 | 50440-1401* | 080 | Ø 32 Hose | Flange | | | SK385-0601 | X4020-269A | 920-0101 | SP6080-0469 | X3001-176F |
| 1106 | 50440-1401* | 080 | Ø 32 Hose | Flange | | | SK385-0601 | X4020-269A | 920-0101 | SP6080-0469 | X3001-176F |
| C6.6 | 50540-1101* | 120 | Ø 45 Hose | Flange | | | | X4020-269A | 17018-0001 | SP6080-0469 | X3001-176F |
| 400 | 50370-2001* | 040 | 3/4" BSP | Flange | | | SK384-0201 | X4020-259A | 1210-0001 | SP6080-0469 | X3001-147F |

SCHWARTING – GERMANY

Mercedes

| | | | | | | | | | | | |
|--------------------|------------|-----|------------|------|---|------------|------------|-----|------------|-------------|------------|
| S 314 / 352 / 352A | 52080-2001 | 080 | 1" BSP | Foot | | | SK406-0001 | 890 | 17937-0001 | SP2700-48 | X3001-147F |
| S 421 / 422 / 423 | 52200-2041 | 200 | 1-1/4" BSP | Foot | | | SK407-0011 | 816 | 17935-0001 | SP6080-0374 | X3001-176F |
| S 424 | 52200-2001 | 200 | 1-1/2" BSP | Foot | • | 52200-2011 | SK407-0011 | 816 | 17935-0001 | SP6080-0374 | X3001-176F |
| S 424 | 52200-2011 | 200 | 1-1/2" BSP | Foot | | | SK407-0011 | 816 | 17935-0001 | SP6080-0374 | X3001-176F |
| S 424A | 52270-2041 | 270 | 2" BSP | Foot | | | SK408-0011 | 816 | 21676-0001 | SP6080-0374 | X3001-176F |

| JABSCO PUMP DETAILS | | | | | | | SERVICE KIT DETAILS | | | | |
|-----------------------------|-------------------------|------|----------------|------------|----------|-----------------------|---------------------|------------------|------------|-------------|------------------|
| MODEL NUMBER | MODEL NUMBER * OEM ONLY | SIZE | PORT SIZE | MOUNT TYPE | OBSOLETE | ALTERNATE PUMP NUMBER | NUMBER | END COVER GASKET | IMPELLER | WATER SEAL | END COVER SCREWS |
| S 615 / 616 / 636 | 3270-261 | 040 | 3/4" BSP | Flange | • | | SK33 | 3298 | 1210-0001 | SP2701-21 | SP1002-02 |
| S 617 / 617A | 23430-1001 | 080 | Ø 32 Hose | Flange | | | SK385-0001 | 890 | 17937-0001 | SP2700-1027 | SP1003-0111 |
| SEATEK – ITALY | | | | | | | | | | | |
| 6.4V.9 | 10770-57 | 200 | 1-1/2" Flanged | Flange | | | SK230 | 816 | 836-0001 | 21849 | SP1005-04 |
| 10.3 Offshore | 29880-0101 | 370 | 2-3/4" Flanged | Flange | • | | SK410 | X4020-424A | 17240-0001 | 21849 | X3001-180F |
| SISU – See VALMET OY | | | | | | | | | | | |
| SOLE DIESEL – SPAIN | | | | | | | | | | | |
| MB 636 | 29500-1001 | 040 | Ø 28 Hose | Flange | • | | SK384-0001 | 3298 | 1210-0001 | SP2700-1027 | SP1002-02 |
| MB 616-4 | 23430-1001 | 080 | Ø 32 Hose | Flange | | | SK385-0001 | 890 | 17937-0001 | SP2700-1027 | SP1003-0111 |
| MB 616-6 | 23430-1001 | 080 | Ø 32 Hose | Flange | | | SK385-0001 | 890 | 17937-0001 | SP2700-1027 | SP1003-0111 |
| SF15 | 21140-204 | 080 | 1" BSP | Flange | • | 21140-2401 | SK229 | 890 | 17937-0001 | 22626-6000 | SP1003-09 |
| SF15 | 21140-2401 | 080 | 1" BSP | Flange | | | SK229 | 890 | 17937-0001 | 22626-6000 | SP1003-09 |
| SF18 | 21140-200 | 080 | 1" BSP | Flange | • | 21140-2401 | SK229 | 890 | 17937-0001 | 22626-6000 | SP1003-09 |
| SF18 | 21140-2401 | 080 | 1" BSP | Flange | | | SK229 | 890 | 17937-0001 | 22626-6000 | SP1003-09 |
| SM 615 | 6490-210 | 040 | 1/2" BSP | Foot | • | | SK225-01 | 6496 | 1210-0001 | SP2701-21 | SP1003-09 |
| SM 636 | 29500-1001 | 040 | Ø 28 Hose | Flange | | | SK384-0001 | 3298 | 1210-0001 | SP2700-1027 | SP1002-02 |
| 6.354.3 | 9710-210 | 080 | 1" BSP | Foot | • | | SK229 | 890 | 17937-0001 | 22626-6000 | SP1003-09 |
| 4.108 | 29500-1001 | 040 | Ø 28 Hose | Flange | | | SK384-0001 | 3298 | 1210-0001 | SP2700-1027 | SP1002-02 |
| TATKO – TURKEY | | | | | | | | | | | |
| | 23050-1031 | 020 | 3/8" BSP | Flange | • | | SK211 | 10817 | 673-0001 | SP2701-04 | SP1002-09 |
| TEMPEST DIESELS – UK | | | | | | | | | | | |
| Captain 31 | 4760-01 | 020 | 3/4" BSP | Flange | • | | SK228 | 2995-0030 | 673-0001 | SP2701-04 | SP1002-01 |
| Captain 31 | 4900-01 | 040 | 1/2" BSP | Foot | • | | SK234 | 4908 | 4568-0001 | 3791 | SP1003-09 |
| Captain 1.5 / 1.8 | 52040-2001 | 040 | 3/4" BSP | Foot | | | SK384-0101 | 3298 | 1210-0001 | SP2701-1015 | X3001-095F |
| Commander 2.2D (DC) | 4760-01 | 020 | 3/4" BSP | Flange | • | | SK228 | 2995-0030 | 673-0001 | SP2701-04 | SP1002-01 |
| Commander 2.5 (HX) | 29500-1001 | 040 | Ø 28 Hose | Flange | | | SK384-0001 | 3298 | 1210-0001 | SP2700-1027 | SP1002-02 |
| Commander 50 HP | 4760-21 | 020 | 3/4" BSP | Flange | • | | SK228 | 2995-0030 | 673-0001 | SP2701-04 | SP1002-01 |
| Commander 50 HP | 4760-111 | 020 | 3/4" BSP | Flange | • | | SK228 | 2995-0030 | 673-0001 | SP2701-04 | SP1002-01 |

11 Flexible Impeller Pumps

COOLING PUMP SPARES BY MAKE OF ENGINE



| JABSCO PUMP DETAILS | | | | | | | SERVICE KIT DETAILS | | | | |
|----------------------------|-------------------------|------|----------------|------------|----------|-----------------------|---------------------|------------------|------------|-------------|------------------|
| MODEL NUMBER | MODEL NUMBER * OEM ONLY | SIZE | PORT SIZE | MOUNT TYPE | OBSOLETE | ALTERNATE PUMP NUMBER | NUMBER | END COVER GASKET | IMPELLER | WATER SEAL | END COVER SCREWS |
| Commander 50 HP (HX) | 3270-241 | 040 | 3/4" BSP | Flange | • | | SK271 | 3298 | 1210-0001 | SP2701-21 | SP1002-02 |
| Commander 50 HP (HX) | 29500-1001 | 040 | Ø 28 Hose | Flange | | | SK384-0001 | 3298 | 1210-0001 | SP2700-1027 | SP1002-02 |
| Commodore 34 / 38 | 4760-01 | 020 | 3/4" BSP | Flange | • | | SK228 | 2995-0030 | 673-0001 | SP2701-04 | SP1002-01 |
| Commodore | 3270-261 | 040 | 3/4" BSP | Flange | • | | SK33 | 3298 | 1210-0001 | SP2701-21 | SP1002-02 |
| Navigator 38 | 4760 | 020 | 3/4" BSP | Flange | • | | SK228 | 2995-0030 | 673-0001 | SP2701-04 | SP1002-01 |
| Sea Lord 51 | 4760-01 | 020 | 3/4" BSP | Flange | • | | SK228 | 2995-0030 | 673-0001 | SP2701-04 | SP1002-01 |
| Sea Lord 51 | 3270-251 | 040 | 3/4" BSP | Flange | • | | SK33 | 3298 | 1210-0001 | SP2701-21 | SP1002-02 |
| Sea Lord 5.66 | 9700 | 080 | 1" Flanged | Flange | • | | SK238 | 890 | 17937-0001 | 22645-0000 | SP1003-01 |
| Sea Prince 3000S | 29500-1001 | 040 | Ø 28 Hose | Flange | | | SK384-0001 | 3298 | 1210-0001 | SP2700-1027 | SP1002-02 |
| Vedette Mk II-VI | 4760 | 020 | 3/4" BSP | Flange | • | | SK228 | 2995-0030 | 673-0001 | SP2701-04 | SP1002-01 |
| Vedette Mk VII | 11430-01 | 010 | 3/4" BSP | Flange | • | | SK272 | 11438 | 4528-0001 | SP2700-11 | SP1002-04 |
| Yeoman 36 | 4760-151 | 020 | 3/4" BSP | Flange | • | | SK228 | 2995-0030 | 673-0001 | SP2701-04 | SP1002-01 |
| 4.58 / 80 | 21140-200 | 080 | 1" BSP | Flange | • | 21140-2401 | SK229 | 890 | 17937-0001 | 22626-6000 | SP1003-09 |
| 6.97 / 120 | 21140-200 | 080 | 1" BSP | Flange | • | 21140-2401 | SK229 | 890 | 17937-0001 | 22626-6000 | SP1003-09 |
| 6.150 / 180 | 21140-200 | 080 | 1" BSP | Flange | • | 21140-2401 | SK229 | 890 | 17937-0001 | 22626-6000 | SP1003-09 |
| 6.150 / 180 | 21140-2401 | 080 | 1" BSP | Flange | | | SK229 | 890 | 17937-0001 | 22626-6000 | SP1003-09 |
| 1622 S | 6540-200 | 020 | 3/8" BSP | Foot | • | 51520-2001 | SK205 | 2995-0030 | 673-0001 | B22 | SP1002-01 |
| UNIVERSAL – USA | | | | | | | | | | | |
| Ford 1.4 | 52010-0051 | 010 | 3/8" NPT | Foot | • | | SK404-0101 | 29308-0000 | 22405-0001 | SP2701-0501 | X3001-095F |
| VALMET OY – FINLAND | | | | | | | | | | | |
| 310 DM / 411 DM | 3370-200 | 040 | 3/4" BSP | Flange | • | 9970-200 | SK33 | 3298 | 1210-0001 | SP2701-21 | SP1002-02 |
| 310 DM / 411 DM | 9970-200 | 040 | 3/4" BSP | Flange | | | SK229 | 3298 | 1210-0001 | 22626-6000 | SP1002-02 |
| 411 / 611 CM / CSM | 9700-21 | 080 | 1" Flanged | Flange | | 29600-1001 | SK238 | 890 | 17937-0001 | SP6080-06 | SP1003-01 |
| 411 / 611 CM / CSM | 29600-1001 | 080 | Ø 32 Hose | Flange | | New Pipework | SK385-0101 | 890 | 17937-0001 | SP6080-0469 | SP1003-0111 |
| 615 / 815 DM | 10770-57 | 200 | 1-1/2" Flanged | Flange | | | SK230 | 816 | 836-0001 | 21849 | SP1005-04 |
| 4035 PM | 4760-41 | 020 | 3/4" BSP | Flange | • | | SK228 | 2995-0030 | 673-0001 | SP2701-04 | SP1002-01 |
| 6-cyl. | 29770-0001 | 200 | 1-1/2" Flanged | Flange | | | | 816 | 17935-0001 | 21849 | SP1095-0640 |
| 612DS | 29770-0001 | 200 | 1-1/2" Flanged | Flange | | | | 816 | 17935-0001 | 21849 | SP1095-0640 |

| JABSCO PUMP DETAILS | | | | | | | SERVICE KIT DETAILS | | | | |
|----------------------------|-------------------------|------|------------|------------|----------|-----------------------|---------------------|------------------|------------|-------------|------------------|
| MODEL NUMBER | MODEL NUMBER * OEM ONLY | SIZE | PORT SIZE | MOUNT TYPE | OBSOLETE | ALTERNATE PUMP NUMBER | NUMBER | END COVER GASKET | IMPELLER | WATER SEAL | END COVER SCREWS |
| VETUS – NETHERLANDS | | | | | | | | | | | |
| C 4 / 6 | 23430-1401 | 080 | Ø 32 Hose | Flange | | | SK385-0001 | 890 | 17937-0001 | SP2700-1027 | SP1003-0111 |
| K 3 / 3D / 4 | 29470-2131C | 020 | 3/8" BSP | Flange | • | | SK405-0001 | 29476-0000 | 18653-0001 | SP2701-1006 | X3004-095G |
| L 2 / 3 | 29460-1251 | 020 | Ø 20 Hose | Flange | • | 29460-10-1051 | SK401-0001 | 2995-0030 | 18653-0001 | SP2701-1006 | SP1002-01 |
| M 2.05 | 29460-1201 | 020 | Ø 20 Hose | Flange | • | 29460-10-1051 | SK401-0001 | 2995-0030 | 18653-0001 | SP2701-1006 | SP1002-01 |
| M 3.10 | 29480-2031C | 020 | 3/8" BSP | Flange | • | 29460-10-1051 | SK405-0001 | 29476-0000 | 18653-0001 | SP2701-1006 | X3004-095G |
| M 4.14 | 3270-2301 | 040 | 3/4" BSP | Flange | • | | SK33 | 3298 | 1210-0001 | SP2701-21 | SP1002-02 |
| P 4.25 | 23430-1441 | 080 | Ø 32 Hose | Flange | | | SK385-0001 | 890 | 17937-0001 | SP2700-1027 | SP1003-0111 |
| STM 6514 | 29530-2001 | 040 | 3/4" BSPF | Crank | | | | 3298 | 1210-0001 | SP2700-1027 | X3001-095F |
| 36-22-11 | 3270-2301 | 040 | 3/4" BSP | Flange | • | | SK33 | 3298 | 1210-0001 | SP2701-21 | SP1002-02 |
| 42-26-Series | 3270-2301 | 040 | 3/4" BSP | Flange | • | | SK33 | 3298 | 1210-0001 | SP2701-21 | SP1002-02 |
| 52-34-Series | 3270-2301 | 040 | 3/4" BSP | Flange | • | | SK33 | 3298 | 1210-0001 | SP2701-21 | SP1002-02 |
| DT43 | 29680-1051 | 080 | Ø 32 Hose | Flange | | | | 890 | 17937-0001 | SP6080-0469 | X3001-147F |
| DTA43 | 29680-1051 | 080 | Ø 32 Hose | Flange | | | | 890 | 17937-0001 | SP6080-0469 | X3001-147F |
| DT64 | 29680-1041 | 080 | Ø 32 Hose | Flange | | | | 890 | 17937-0001 | SP6080-0469 | X3001-147F |
| DTA64 | 29680-1041 | 080 | Ø 32 Hose | Flange | | | | 890 | 17937-0001 | SP6080-0469 | X3001-147F |
| DT67 | 29680-1041 | 080 | Ø 32 Hose | Flange | | | | 890 | 17937-0001 | SP6080-0469 | X3001-147F |
| DTA67 | 29680-1041 | 080 | Ø 32 Hose | Flange | | | | 890 | 17937-0001 | SP6080-0469 | X3001-147F |
| M 4.15 / M 4.17 | 29460-10-1041 | 020 | Ø 20 Hose | Flange | | | - | X5251-049 | 653-0001 | SP2701-1006 | x3001-174F |
| M 2 / M 3 | 29460-10-1051 | 020 | Ø 20 Hose | Flange | | | - | X5251-049 | 653-0001 | SP2701-1006 | x3001-174F |
| VM-MOTORI – ITALY | | | | | | | | | | | |
| 102 MH-Series | 11000-01 | 020 | Ø 16 Hose | Flange | • | | SK211 | 10817 | 673-0001 | SP2701-04 | SP1002-09 |
| 103 / 4 / 6 MH-Series | 29500-1001 | 040 | Ø 28 Hose | Flange | | | SK384-0001 | 3298 | 1210-0001 | SP2700-1027 | SP1002-02 |
| 106 M11 | 11000-01 | 020 | Ø 16 Hose | Flange | • | | SK211 | 10817 | 673-0001 | SP2701-04 | SP1002-09 |
| 114 / 6 MH | 9700-21 | 080 | 1" Flanged | Flange | | 29600-1001 | SK238 | 890 | 17937-0001 | SP6080-06 | SP1003-01 |
| 114 / 6 MH | 29600-1001 | 080 | Ø 32 Hose | Flange | | New Pipework | SK385-0101 | 890 | 17937-0001 | SP6080-0469 | SP1003-0111 |
| 116 DAN M | 29500-1001 | 040 | Ø 28 Hose | Flange | | | SK384-0001 | 3298 | 1210-0001 | SP2700-1027 | SP1002-02 |

11 Flexible Impeller Pumps

COOLING PUMP SPARES BY MAKE OF ENGINE



| JABSCO PUMP DETAILS | | | | | | | SERVICE KIT DETAILS | | | | |
|-----------------------------|-------------------------|------|----------------|------------|----------|-----------------------|---------------------|------------------|------------|-------------|------------------|
| MODEL NUMBER | MODEL NUMBER * OEM ONLY | SIZE | PORT SIZE | MOUNT TYPE | OBSOLETE | ALTERNATE PUMP NUMBER | NUMBER | END COVER GASKET | IMPELLER | WATER SEAL | END COVER SCREWS |
| HR-Series | 23430-1001 | 080 | Ø 32 Hose | Flange | | | SK385-0001 | 890 | 17937-0001 | SP2700-1027 | SP1003-0111 |
| HR 694 HID10 | 29700-1301 | 120 | Ø 45 Hose | Flange | | | SK386-0001 | 890 | 17018-0001 | SP6080-0469 | SP1003-0111 |
| 804 / 806 M | 29500-1001 | 040 | Ø 28 Hose | Flange | | | SK384-0001 | 3298 | 1210-0001 | SP2700-1027 | SP1002-02 |
| 956 M11 | 11000-01 | 020 | Ø 16 Hose | Flange | • | | SK211 | 10817 | 673-0001 | SP2701-04 | SP1002-09 |
| 130 MH 14-Series | 10880-0101 | 200 | 1-1/2" Flanged | Flange | • | | SK230 | 816 | 836-0001 | 21849 | SP1005-04 |
| 131 MH 14-Series | 11100-0101 | 270 | 2" Flanged | Flange | • | | SK254 | 816 | 21676-0001 | 21849 | SP1005-04 |
| VOLVO PENTA – SWEDEN | | | | | | | | | | | |
| AQ 95 | 9900 | 020 | Ø 16 Hose | Foot | • | 29470-2231C | SK211 | 10817 | 673-0001 | SP2701-04 | SP1002-09 |
| AQ 95 | 29470-2231C | 020 | 3/8" BSP | Flange | | | SK405-0001 | 29476-0000 | 18653-0001 | SP2701-1006 | X3004-095G |
| AQ 110 / 115 / BB 115 | 9900 | 020 | Ø 16 Hose | Foot | • | 29470-2231C | SK211 | 10817 | 673-0001 | SP2701-04 | SP1002-09 |
| AQ 110 / 115 / BB 115 | 29470-2231C | 020 | 3/8" BSP | Flange | | | SK405-0001 | 29476-0000 | 18653-0001 | SP2701-1006 | X3004-095G |
| AQ 115 A / B | 29470-1231 | 020 | Ø 16 Hose | Flange | • | | SK405-0001 | 29476-0000 | 18653-0001 | SP2701-1006 | X3004-095G |
| AQ 130 C / D | 9900 | 020 | Ø 16 Hose | Foot | • | 29470-2231C | SK211 | 10817 | 673-0001 | SP2701-04 | SP1002-09 |
| AQ 130 C / D | 29470-2231C | 020 | 3/8" BSP | Flange | | | SK405-0001 | 29476-0000 | 18653-0001 | SP2701-1006 | X3004-095G |
| AQ 130 C / D | 29470-1231 | 020 | Ø 16 Hose | Flange | • | | SK405-0001 | 29476-0000 | 18653-0001 | SP2701-1006 | X3004-095G |
| AQ 140 | 9900 | 020 | Ø 16 Hose | Foot | • | 29470-2231C | SK211 | 10817 | 673-0001 | SP2701-04 | SP1002-09 |
| AQ 140 | 29470-2231C | 020 | 3/8" BSP | Flange | | | SK405-0001 | 29476-0000 | 18653-0001 | SP2701-1006 | X3004-095G |
| AQ 140 | 29470-1231 | 020 | Ø 16 Hose | Flange | • | | SK405-0001 | 29476-0000 | 18653-0001 | SP2701-1006 | X3004-095G |
| AQ 140 A | 10-32621-1 | | | | | Johnson Pump | | | 4568-0001 | | |
| AQ 145 A / B | 10-32621-1 | | | | | Johnson Pump | | | 4568-0001 | | |
| AQ 150 | 14620 | 080 | 1" Hose | Flange | • | | SK153 | 890 | 4598-0001 | SP6080-08B | SP1014-03 |
| AQ 151 A / B / C | 10-32621-1 | | | | | Johnson Pump | | | 4568-0001 | | |
| AQ 175 A | 22740-0251 | 060 | Ø 32 Hose | Crank | • | 22740-0151 | SK331-0251 | 3298 | 22120-0001 | SP2701-21 | SP8019-01 |
| AQ 175 A | 22740-0151 | 060 | Ø 32 Hose | Crank | • | | SK331-05 | 3298 | 22120-0001 | SP2701-21 | SP8019-01 |
| AQ 180 | 10550-01 | 040 | 3/4" NPT | Foot | • | | SK239 | 3298 | 1210-0001 | 22626-6000 | SP1002-02 |
| AQ 200 | 22300-05 | 060 | Ø 32 Hose | Crank | • | | SK331-05 | 3298 | 22120-0001 | SP6080-08B | SP8019-01 |
| AQ 200 D | 22740-0251 | 060 | Ø 32 Hose | Crank | • | 22740-0151 | SK331-0251 | 3298 | 22120-0001 | SP2701-21 | SP8019-01 |
| AQ 200 D | 22740-0151 | 060 | Ø 32 Hose | Crank | • | | SK331-05 | 3298 | 22120-0001 | SP2701-21 | SP8019-01 |
| AQ 200 D-280 / 225 | 22300-05 | 060 | Ø 32 Hose | Crank | • | | SK331-05 | 3298 | 22120-0001 | SP6080-08B | SP8019-01 |

| JABSCO PUMP DETAILS | | | | | | | SERVICE KIT DETAILS | | | | |
|---------------------|-------------------------|------|-----------|------------|----------|-----------------------|---------------------|--------------------------------------|------------|-------------|------------------|
| MODEL NUMBER | MODEL NUMBER * OEM ONLY | SIZE | PORT SIZE | MOUNT TYPE | OBSOLETE | ALTERNATE PUMP NUMBER | NUMBER | END COVER GASKET | IMPELLER | WATER SEAL | END COVER SCREWS |
| AQ 225 D | 22740-0251 | 060 | Ø 32 Hose | Crank | • | 22740-0151 | SK331-0251 | 3298 | 22120-0001 | SP2701-21 | SP8019-01 |
| AQ 225 D | 22740-0151 | 060 | Ø 32 Hose | Crank | • | | SK331-05 | 3298 | 22120-0001 | SP2701-21 | SP8019-01 |
| AQ 225 B / D-280 | 22300-05 | 060 | Ø 32 Hose | Crank | • | | SK331-05 | 3298 | 22120-0001 | SP6080-08B | SP8019-01 |
| AQ 250 | 22300-05 | 060 | Ø 32 Hose | Crank | • | | SK331-05 | 3298 | 22120-0001 | SP6080-08B | SP8019-01 |
| AQ 260 A | 22740-0251 | 060 | Ø 32 Hose | Crank | • | 22740-0151 | SK331-0251 | 3298 | 22120-0001 | SP2701-21 | SP8019-01 |
| AQ 260 B | 22740-0151 | 060 | Ø 32 Hose | Crank | • | | SK331-05 | 3298 | 22120-0001 | SP2701-21 | SP8019-01 |
| AQ 270 | 22300-05 | 060 | Ø 32 Hose | Crank | • | | SK331-05 | 3298 | 22120-0001 | SP6080-08B | SP8019-01 |
| AQ 290 A | 22740-0251 | 060 | Ø 32 Hose | Crank | • | 22740-0151 | SK331-0251 | 3298 | 22120-0001 | SP2701-21 | SP8019-01 |
| AQ 290 A | 22740-0151 | 060 | Ø 32 Hose | Crank | • | | SK331-05 | 3298 | 22120-0001 | SP2701-21 | SP8019-01 |
| AQ 740 Big Block | 22740-0201 | 060 | Ø 32 Hose | Crank | • | | SK331-0251 | 3298 | 22120-0001 | SP2701-21 | SP8019-01 |
| AQD 21A | 10-32058-1 | 040 | | | | Johnson Pump | | | 4568-0001 | | |
| AQD 21B | 10-32058-1 | 040 | | | | Johnson Pump | | | 4568-0001 | | |
| AQD 40A | 10800-21 | 080 | 1" NPSF | Flange | • | | SK229 | 890 | 17937-0001 | 22617-0010 | SP1003-09 |
| | 10-24277-1 | 080 | 1" NPSF | Flange | | Johnson Pump | | | 17937-0001 | | |
| BB 30 | 9900 | 020 | Ø 16 Hose | Foot | • | 29470-2231C | SK211 | 10817 | 673-0001 | SP2701-04 | SP1002-09 |
| BB 30 | 29470-2231C | 020 | 3/8" BSP | Flange | | | SK405-0001 | 29476-0000 | 18653-0001 | SP2701-1006 | X3004-095G |
| BB 70 | 6490-246 | 040 | 1/2" BSP | Foot | • | 6490-224 | SK225-01 | Use 23299 Kit to upgrade to 6490-224 | | | |
| BB 100 | 6490-246 | 040 | 1/2" BSP | Foot | • | 6490-224 | SK225-01 | Use 23299 Kit to upgrade to 6490-224 | | | |
| MB 10A | 11260-2101 | 010 | 3/8" BSP | Flange | • | 29300-2201C | SK266 | 1126 | 4528-0001 | SP2701-04 | SP1002-01 |
| MB 10A / 11 | 29300-2201C | 010 | 3/8" BSP | Flange | • | | SK404-0001 | 29308-0000 | 22405-0001 | SP2701-1006 | X3004-095G |
| MB 16A | 9400 | 020 | Ø 16 Hose | Flange | • | | SK211 | 10817 | 673-0001 | SP2701-04 | SP1002-09 |
| MB 36A | 6490-241 | 040 | 1/2" BSP | Foot | • | 6490-222 | SK225-01 | Use 23299 Kit to upgrade to 6490-224 | | | |
| MB 36B | 10550-01 | 040 | 3/4" NPT | Foot | • | | SK239 | 3298 | 1210-0001 | 22626-6000 | SP1002-02 |
| MBN 40 | 21770 | 040 | Ø 32 Hose | Flange | • | | SK309 | 4908 | 4568-0001 | SP2701-01 | SP1003-09 |
| MD 1 / 1A / 1B | 11260-2101 | 010 | 3/8" BSP | Flange | • | 29300-2201C | SK266 | 1126 | 4528-0001 | SP2701-04 | SP1002-01 |
| MD 1 KHD / HY / 2 | 11260-2101 | 010 | 3/8" BSP | Flange | • | 29300-2201C | SK266 | 1126 | 4528-0001 | SP2701-04 | SP1002-01 |
| MD 1 KHD / HY / 2 | 29300-2201C | 010 | 3/8" BSP | Flange | • | | SK404-0001 | 29308-0000 | 22405-0001 | SP2701-1006 | X3004-095G |
| MD2 / 2B | 29300-2201C | 010 | 3/8" BSP | Flange | • | | SK404-0001 | 29308-0000 | 22405-0001 | SP2701-1006 | X3004-095G |

11 Flexible Impeller Pumps

COOLING PUMP SPARES BY MAKE OF ENGINE



| JABSCO PUMP DETAILS | | | | | | | SERVICE KIT DETAILS | | | | |
|---------------------|-------------------------|------|----------------|------------|----------|-----------------------|---------------------|------------------|------------|-------------|------------------|
| MODEL NUMBER | MODEL NUMBER * OEM ONLY | SIZE | PORT SIZE | MOUNT TYPE | OBSOLETE | ALTERNATE PUMP NUMBER | NUMBER | END COVER GASKET | IMPELLER | WATER SEAL | END COVER SCREWS |
| MD 2 BHY | 11260-2101 | 010 | 3/8" BSP | Flange | • | 29300-2201C | SK266 | 1126 | 4528-0001 | SP2701-04 | SP1002-01 |
| MD 2 BHY | 29300-2201C | 010 | 3/8" BSP | Flange | • | | SK404-0001 | 29308-0000 | 22405-0001 | SP2701-1006 | X3004-095G |
| MD 3 | 9900 | 020 | Ø 16 Hose | Foot | • | 29470-2231C | SK211 | 10817 | 673-0001 | SP2701-04 | SP1002-09 |
| MD 3 | 29470-2231C | 020 | 3/8" BSP | Flange | | | SK405-0001 | 29476-0000 | 18653-0001 | SP2701-1006 | X3004-095G |
| MD 3 | 29470-1231C | 020 | Ø 16 Hose | Flange | | | SK405-0001 | 29476-0000 | 18653-0001 | SP2701-1006 | X3004-095G |
| MD 5A / B / C | 29300-2201C | 010 | 3/8" BSP | Flange | • | | SK404-0001 | 29308-0000 | 22405-0001 | SP2701-1006 | X3004-095G |
| MD 6A / B | 11260-2101 | 010 | 3/8" BSP | Flange | • | 29300-2201C | SK266 | 1126 | 4528-0001 | SP2701-04 | SP1002-01 |
| MD 7A / B | 11260-2101 | 010 | 3/8" BSP | Flange | • | 29300-2201C | SK266 | 1126 | 4528-0001 | SP2701-04 | SP1002-01 |
| MD 10A / 11 | 29300-2001C | 010 | 3/8" BSP | Flange | • | | SK404-0001 | 29308-0000 | 22405-0001 | SP2701-1006 | X3004-095G |
| MD11 C | 29300-2001C | 010 | 3/8" BSP | Flange | • | | SK404-0001 | 29308-0000 | 22405-0001 | SP2701-1006 | X3004-095G |
| MD11 D | 29300-2001C | 010 | 3/8" BSP | Flange | • | | SK404-0001 | 29308-0000 | 22405-0001 | SP2701-1006 | X3004-095G |
| MD 21A | 10-32058-1 | 040 | | Flange | | Johnson Pump | | | 4568-0001 | | |
| MD 21B | 10-32058-1 | 040 | | Flange | | Johnson Pump | | | 4568-0001 | | |
| MD 22 | 29500-1001 | 040 | Ø 28 Hose | Flange | | | SK384-0001 | 3298 | 1210-0001 | SP2700-1027 | SP1002-02 |
| MD22 / SX | 29540-1001 | 040 | Ø 28 Hose | Foot | • | | SK384-0101 | 3298 | 1210-0001 | SP2700-1027 | X3001-095F |
| MD 32A | 10800-21 | 080 | 1" NPSF | Flange | • | | SK229 | 890 | 17937-0001 | 22617-0010 | SP1003-09 |
| MD40A | 10-24277-1 | 080 | 1" NPSF | Flange | | Johnson Pump | | | 17937-0001 | | |
| MD 47A / C | 9710-200 | 080 | 1" BSP | Foot | | | SK229 | 890 | 17937-0001 | 22626-6000 | SP1003-09 |
| MD 47B | 9770-205 | 080 | 3/4" BSP | Barrel | • | | SK229 | 890 | 17937-0001 | 22626-6000 | SP1003-09 |
| MD 50A | 11120-204 | 080 | 1" BSP | Flange | • | | SK229 | 890 | 17937-0001 | 22626-6000 | SP1003-09 |
| MD 67C | 9770-205 | 080 | 3/4" BSP | Barrel | • | | SK229 | 890 | 17937-0001 | 22626-6000 | SP1003-09 |
| MD 70A | 11120-204 | 080 | 1" BSP | Flange | • | | SK229 | 890 | 17937-0001 | 22626-6000 | SP1003-09 |
| MD 70 | 11120-205 | 080 | 1" BSP | Flange | • | | SK229 | 890 | 17937-0001 | 22626-6000 | SP1003-09 |
| MD 71 | 10770-0051 | 200 | 1-1/2" Flanged | Flange | • | | SK369-0001 | 816 | 836-0001 | 21849 | SP1095-0640 |
| MD 71 | 10770-0351 | 200 | 1-1/2" Flanged | Flange | | | SK230 | 816 | 836-0001 | 21849 | SP1005-04 |
| MD 96B | 9710-200 | 080 | 1" BSP | Foot | | | SK229 | 890 | 17937-0001 | 22626-6000 | SP1003-09 |
| MD 2010 | 29350-1101 | 010 | Ø 20 Hose | Flange | | | SK23-0101 | 1126 | 4528-0001 | SP2701-14 | SP1002-01 |
| MD 2020 | 29350-1101 | 010 | Ø 20 Hose | Flange | | | SK23-0101 | 1126 | 4528-0001 | SP2701-14 | SP1002-01 |
| MD 2030 | 29450-1301 | 020 | Ø 20 Hose | Flange | | | SK387-0001 | 2995-0030 | 673-0001 | SP2700-05 | SP1002-01 |

| JABSCO PUMP DETAILS | | | | | | | SERVICE KIT DETAILS | | | | |
|---------------------|-------------------------|------|----------------|------------|----------|-----------------------|---------------------|------------------|------------|-------------|------------------|
| MODEL NUMBER | MODEL NUMBER * OEM ONLY | SIZE | PORT SIZE | MOUNT TYPE | OBSOLETE | ALTERNATE PUMP NUMBER | NUMBER | END COVER GASKET | IMPELLER | WATER SEAL | END COVER SCREWS |
| MD 2040 | 29450-1401 | 020 | Ø 20 Hose | Flange | | | SK387-0001 | 2995-0030 | 673-0001 | SP2700-05 | SP1002-01 |
| TAMD 22 / SX | 29540-1001 | 040 | Ø 28 Hose | Foot | • | | SK384-0101 | 3298 | 1210-0001 | SP2700-1027 | X3001-095F |
| TAMD 60 | 11120-205 | 080 | 1" BSP | Flange | • | | SK229 | 890 | 17937-0001 | 22626-6000 | SP1003-09 |
| TAMD 61 | 10770-0051 | 200 | 1-1/2" Flanged | Flange | • | | SK369-0001 | 816 | 836-0001 | 21849 | SP1095-0640 |
| TAMD 61 | 10770-0351 | 200 | 1-1/2" Flanged | Flange | | | SK230 | 816 | 836-0001 | 21849 | SP1005-04 |
| TAMD 70 | 11120-205 | 080 | 1" BSP | Flange | • | | SK229 | 890 | 17937-0001 | 22626-6000 | SP1003-09 |
| TAMD 71 | 10770-0051 | 200 | 1-1/2" Flanged | Flange | • | | SK369-0001 | 816 | 836-0001 | 21849 | SP1095-0640 |
| TAMD 71 | 10770-0351 | 200 | 1-1/2" Flanged | Flange | | | SK230 | 816 | 836-0001 | 21849 | SP1005-04 |
| TAMD 96B | 9710-200 | 080 | 1" BSP | Foot | | | SK229 | 890 | 17937-0001 | 22626-6000 | SP1003-09 |
| TAMD 102 | 10590-0031 | 270 | 2" Flanged | Flange | • | | SK254 | 816 | 21676-0001 | 21849 | SP1005-04 |
| TMD22 / SX | 29540-1001 | 040 | Ø 28 Hose | Foot | • | | SK384-0101 | 3298 | 1210-0001 | SP2700-1027 | X3001-095F |
| TMD40A | 10-24277-1 | 080 | 1" BSP | Flange | | Johnson Pump | | | 17937-0001 | | |
| TMD40B | 10-24277-1 | 080 | 1" BSP | Flange | | Johnson Pump | | | 17937-0001 | | |
| TMD 50A | 11120-204 | 080 | 1" BSP | Flange | • | | SK229 | 890 | 17937-0001 | 22626-6000 | SP1003-09 |
| TMD 70 | 11120-205 | 080 | 1" BSP | Flange | • | | SK229 | 890 | 17937-0001 | 22626-6000 | SP1003-09 |
| TMD 71 | 10770-0051 | 200 | 1-1/2" Flanged | Flange | • | | SK369-0001 | 816 | 836-0001 | 21849 | SP1095-0640 |
| TMD 71 | 10770-0351 | 200 | 1-1/2" Flanged | Flange | | | SK230 | 816 | 836-0001 | 21849 | SP1005-04 |
| TMD 96B | 9710-200 | 080 | 1" BSP | Foot | | | SK229 | 890 | 17937-0001 | 22626-6000 | SP1003-09 |
| TMD 100A / C | 10590-0041 | 270 | 2" Flanged | Flange | • | | SK254 | 816 | 21676-0001 | 21849 | SP1005-04 |
| TMD 120 B | 10590-0041 | 270 | 2" Flanged | Flange | • | | SK254 | 816 | 21676-0001 | 21849 | SP1005-04 |
| TMD 121 C | 10590-0041 | 270 | 2" Flanged | Flange | • | | SK254 | 816 | 21676-0001 | 21849 | SP1005-04 |
| 1113 BR | 9710-200 | 080 | 1" BSP | Foot | | | SK229 | 890 | 17937-0001 | 22626-6000 | SP1003-09 |
| D4 | 50380-1001* | 080 | Ø 38/45 Hose | Flange | | | | X5251-052 | 17937-0001 | SP6080-0469 | X3001-178F |
| D6 | 50390-1201* | 120 | Ø 45/50 Hose | Flange | | | | X5251-052 | 17018-0001 | SP6080-0469 | X3001-178F |
| D9 | 50430-0301* | 120 | Hose/Flange | Flange | | | | X4020-269A | 17018-0001 | SP6080-0469 | X3001-176F |
| D11 | 50590-0001* | 200 | Hose/Flange | Flange | | | | X4020-399A | 836-0001 | 21849 | X3001-178F |
| D13 | 50570-0001* | 300 | Flange | Flange | | | | X4020-399A | 17938-0001 | 21849 | X3001-176F |

11 Flexible Impeller Pumps

COOLING PUMP SPARES BY MAKE OF ENGINE



| JABSCO PUMP DETAILS | | | | | | | SERVICE KIT DETAILS | | | | |
|---------------------|-------------------------|------|-------------|------------|----------|-----------------------|---------------------|------------------|------------|------------|------------------|
| MODEL NUMBER | MODEL NUMBER * OEM ONLY | SIZE | PORT SIZE | MOUNT TYPE | OBSOLETE | ALTERNATE PUMP NUMBER | NUMBER | END COVER GASKET | IMPELLER | WATER SEAL | END COVER SCREWS |
| D13 Commercial | 50680-0031* | 300 | Flange | Flange | | | | X4020-399A | 17938-0001 | 21849 | X3001-176F |
| D16 | 50500-0001* | 300 | Flange | Flange | | | | X4020-399A | 17938-0001 | 21849 | X3001-176F |
| D16 Keel Cooled | 50530-0101* | 080 | Hose/Flange | Flange | | | | X4020-269A | 17937-0001 | 96080-0626 | X3001-178F |

WATERMOTA – UK

Sea-Series

| | | | | | | | | | | | |
|------------------|-------------|-----|-----------|--------|---|-------------|------------|------------|------------|-------------|-------------|
| Beaver / Cub | 52010-2051 | 010 | 3/8" BSP | Foot | • | | SK404-0101 | 29308-0000 | 22405-0001 | SP2701-0501 | X3001-095F |
| Horse | 21690 | 040 | Ø 20 Hose | Flange | • | | SK239 | 3298 | 1210-0001 | 22626-6000 | SP1002-02 |
| Horse | 21690-05 | 040 | Ø 20 Hose | Flange | • | | SK239 | 3298 | 1210-0001 | 22626-6000 | SP1002-02 |
| Lion | 10950-200 | 040 | 3/4" BSP | Flange | • | 10950-2401 | SK239 | 3298 | 1210-0001 | 22626-6000 | SP1002-02 |
| Lion | 10950-2401 | 040 | 3/4" BSP | Flange | | | SK239 | 3298 | 1210-0001 | 22626-6000 | SP1002-02 |
| Lion | 21140-201 | 080 | 1" BSP | Flange | • | 21140-2401 | SK229 | 890 | 17937-0001 | 22626-6000 | SP1003-09 |
| Lion | 21140-2401 | 080 | 1" BSP | Flange | | | SK229 | 890 | 17937-0001 | 22626-6000 | SP1003-09 |
| Leopard | 9900 | 020 | Ø 16 Hose | Foot | • | 29470-2231C | SK211 | 10817 | 673-0001 | SP2701-04 | SP1002-09 |
| Leopard | 29470-2231C | 020 | 3/8" BSP | Flange | | | SK405-0001 | 29476-0000 | 18653-0001 | SP2701-1006 | X3004-095G |
| Otter | 9430-211 | 010 | 1/4" BSP | Flange | • | 29300-2601C | SK221 | 1126 | 4528-0001 | SP2701-09 | SP1002-01 |
| Otter | 29300-2601C | 010 | 3/8" BSP | Flange | | | SK404-0001 | 29308-0000 | 22405-0001 | SP2701-1006 | X3004-095G |
| Panther Mk 3 / 4 | 9900 | 020 | Ø 16 Hose | Foot | • | 29470-2231C | SK211 | 10817 | 673-0001 | SP2701-04 | SP1002-09 |
| Panther Mk 3 / 4 | 29470-2231C | 020 | 3/8" BSP | Flange | | | SK405-0001 | 29476-0000 | 18653-0001 | SP2701-1006 | X3004-095G |
| Ranger | 23430-1201 | 080 | Ø 32 Hose | Flange | | | SK385-0001 | 890 | 17937-0001 | SP2700-1027 | SP1003-0111 |
| Scout | 10950-200 | 040 | 3/4" BSP | Flange | • | 10950-2401 | SK239 | 3298 | 1210-0001 | 22626-6000 | SP1002-02 |

| JABSCO PUMP DETAILS | | | | | | | SERVICE KIT DETAILS | | | | |
|-------------------------|-------------------------|------|-----------|------------|----------|-----------------------|---------------------|------------------|------------|-------------|------------------|
| MODEL NUMBER | MODEL NUMBER * OEM ONLY | SIZE | PORT SIZE | MOUNT TYPE | OBSOLETE | ALTERNATE PUMP NUMBER | NUMBER | END COVER GASKET | IMPELLER | WATER SEAL | END COVER SCREWS |
| Scout | 10950-2401 | 040 | 3/4" BSP | Flange | | | SK239 | 3298 | 1210-0001 | 22626-6000 | SP1002-02 |
| Scout | 21140-201 | 080 | 1" BSP | Flange | • | 21140-2401 | SK229 | 890 | 17937-0001 | 22626-6000 | SP1003-09 |
| Scout | 21140-2401 | 080 | 1" BSP | Flange | | | SK229 | 890 | 17937-0001 | 22626-6000 | SP1003-09 |
| Tiger / Wolf | 9430-211 | 010 | 3/4" BSP | Flange | • | 29300-2601C | SK221 | 1126 | 4528-0001 | SP2701-09 | SP1002-01 |
| Tiger / Wolf | 29300-2601C | 010 | 3/8" BSP | Flange | | | SK404-0001 | 29308-0000 | 22405-0001 | SP2701-1006 | X3004-095G |
| Tiger / Wolf | 9900 | 020 | Ø 16 Hose | Foot | • | 29470-2231C | SK211 | 10817 | 673-0001 | SP2701-04 | SP1002-09 |
| Tiger / Wolf | 29470-2231C | 020 | 3/8" BSP | Flange | | | SK405-0001 | 29476-0000 | 18653-0001 | SP2701-1006 | X3004-095G |
| Tiger / Wolf | 29410-1101 | 020 | Ø 20 Hose | Flange | • | | SK404-0001 | 29308-0000 | 18653-0001 | SP2701-1006 | X3004-095G |
| Series 11-30 / 50 | 22770 | 020 | Ø 25 Hose | Crank | • | 29440-1001 | SK346 | 1985-01 | 673-0001 | SP2701-21 | SP1004-09 |
| Series 11-30 / 50 | 29440-1001 | 020 | Ø 25 Hose | Crank | | | SK402-0001 | 1985-0000 | 18653-0001 | 29441-0000 | SP1004-09 |
| Inlander | 2620-253 | 020 | 3/8" BSP | Foot | • | | SK20 | 2995-0030 | 673-0001 | SP2700-05 | SP1002-02 |
| Type 5-16 | 9430-211 | 010 | 1/4" BSP | Flange | • | 29300-2601C | SK221 | 1126 | 4528-0001 | SP2701-09 | SP1002-01 |
| Type 5-16 | 29300-2601C | 010 | 3/8" BSP | Flange | | | SK404-0001 | 29308-0000 | 22405-0001 | SP2701-1006 | X3004-095G |
| WESTERBEKE – USA | | | | | | | | | | | |
| Generator Sets | | | | | | | | | | | |
| 8-10 kW | 52010-2051 | 010 | 3/8" NPT | Foot | • | | SK404-0101 | 29308-0000 | 22405-0001 | SP2701-0501 | X3001-095F |
| 10+ kW | 52020-2031 | 020 | 3/8" NPTF | Foot | • | | SK405-0101 | 2995-0030 | 18653-0001 | SP2701-0501 | X3001-095F |
| ZEISE – GERMANY | | | | | | | | | | | |
| Kubota Twin | 29460-2501 | 020 | 3/8" BSP | Flange | | | SK401-0001 | 2995-0030 | 18653-0001 | SP2701-1006 | SP1002-01 |